

# Fair

## ECOCOMFORT 2 SMART

SMART  
SINGLE ROOM  
HEAT RECOVERY UNIT



reddot winner 2021



# ECOCOMFORT 2 SMART

The smart ventilation system, **so that you never have to give up your #multicomfort.**

From the most recent technological and regulatory evolutions in the field of construction, two fundamental principles prevail: limiting energy consumption and improving indoor quality and therefore temperature, humidity and purity.

Today, with the modern insulating materials and new generation systems, buildings need constant air renewal, which forces us to open the windows often, thus wasting a considerable amount of thermal energy.

A practical solution? The decentralised ventilation units of the Ecocomfort series offered by Aspira, the Fantini Cosmi brand dedicated to air handling, are perfect for **guaranteeing the right air renewal in small rooms**, without having to forego on heat recovery in every season, **even in cases where large ventilation systems are not possible or necessary.**





## IT ALSO CONTROLS AIR QUALITY

The ECOCOMFORT 2 SMART heat recovery unit also controls air quality to bring **wellness and comfort to your everyday life.**

## CONFIGURATION AND CONTROL FROM THE APP

ECOCOMFORT 2 SMART has a multi-connectivity system that integrates with the *Intelliclimate+* App, an actual "hub" where you can configure all the Fantini Cosmi programmable thermostats installed in the home, in view of an "integrated" smart home.

## COMFORT WITH FULL PEACE OF MIND

Temperature, relative humidity, brightness and VOC sensors allow the ECOCOMFORT 2 SMART unit to adopt the most suitable ventilation mode entirely autonomously and ensure the best level of comfort in the room.

## SINGLE-ROOM AND MULTI-ROOM

ECOCOMFORT 2 SMART can be used as a spot system **for a single room or**, by configuring multiple ventilation units, it is possible to create **a multi-room ventilation system.**

# BREATHE CLEAN AIR AND SAVE ENERGY

It renews air, prevents  
mildew and humidity and  
saves on the costs of  
heating and cooling!



ECOCOMFORT 2 SMART is the decentralised ventilation and intake unit with very high heat recovery efficiency, which **guarantees continuous and constant air renewal, avoids energy losses** caused by opening windows and guarantees heat recovery even greater than 90%, in the winter and summer seasons, thus contributing to a considerable energy recovery of the renewal air fed into the room, considerably lowering the costs of heating and cooling.



The continuous use of the unit protects the building against the formation of humidity and mildew, also reducing the frequency of seasonal illnesses of the occupants, such as colds and allergies due to concentrations of pollens, bacteria and polluting particulate that are constantly filtered.



## RECIRCULATION OF AIR WITH ALTERNATED AIR FLOW

ECOCOMFORT 2 SMART ventilation units are controlled by a low consumption brushless DC motor which reverses the cycle, allowing for the continuous exchange of air between the inside and outdoors.

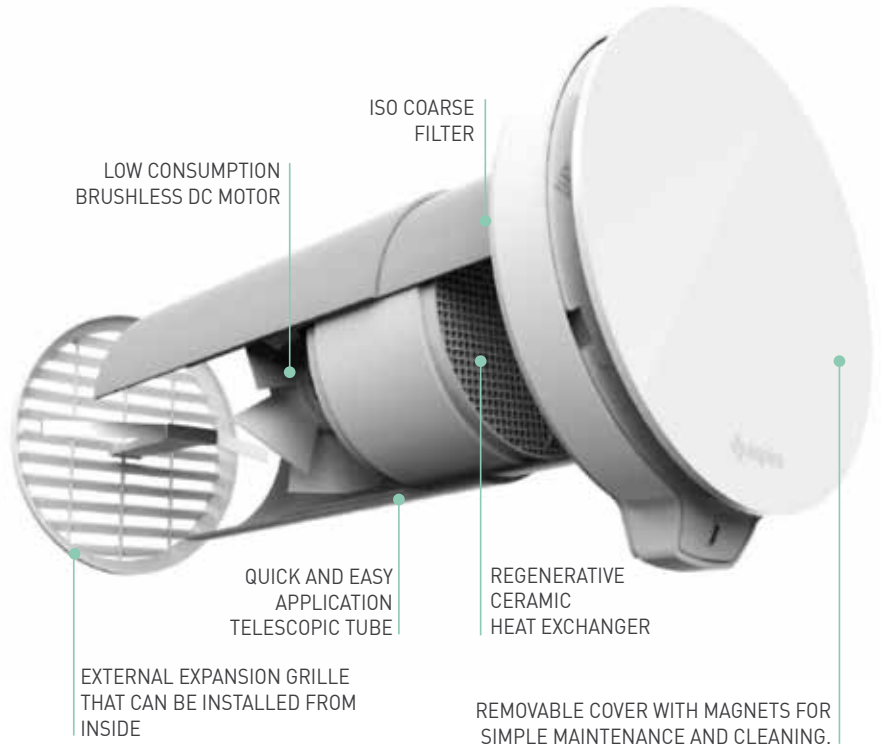

The air is constantly filtered by a "ISO Coarse" filter installed at the front of the equipment and that can be easily taken out to allow for periodical cleaning.

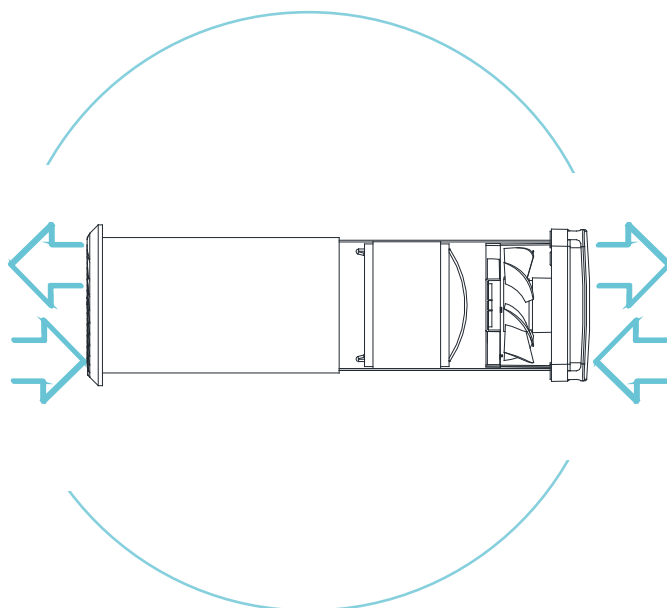

## UP TO 90% HEAT RECOVERY

In alternated air flow mode with heat recovery, the flow of incoming air and the flow of outgoing air pass through a ceramic heat exchanger which recovers up to 90% of the heat contained in the outgoing air and introduces it in the incoming air when the unit reverses the ventilation cycle.

The continuous use of the unit helps prevent dampness, the formation of mould on the walls and maintains a constantly low level of pollutants.

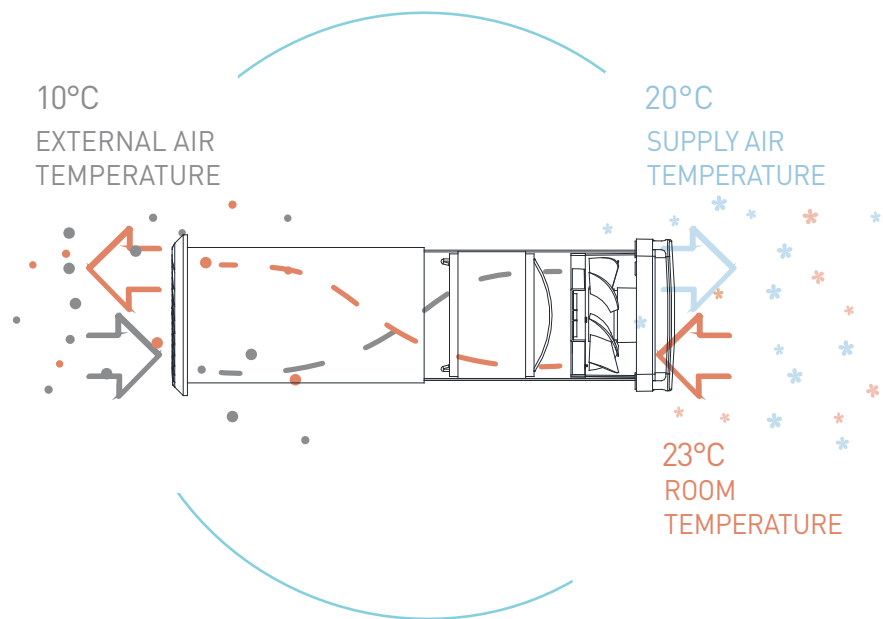

### ALSO IN THE SUMMER: FRESH AIR

In summer, ECOCOMFORT 2 SMART **eliminates excess humidity and recovers "cold" from the AC air** drawn from the room and transfers it to the air fed in with a guaranteed benefit in terms of comfort and energy efficiency.

For example, thanks to the **Free Cooling function**, in summer – when the outdoor temperature is lower than the indoor one – the function helps to ensure greater thermal comfort.

# AWARDED FOR THE DESIGN, APPRECIATED BY THE INSTALLERS



reddot winner 2021

Already assigned with the prestigious international Red Dot Design Award 2021, ECOCOMFORT 2 SMART combines aesthetics with great practicality, appreciated by installation technicians.

- **Control from App** on iOS and Android devices.
- Air flow, temperature, relative humidity, brightness and VOC sensors.
- **Weekly programming** of operation and possibility of **voice control** with Amazon Alexa™ smart speaker. <sup>[\*]</sup>
- **Bluetooth (BLE)** and **WIFI** communication system.
- **Removable cover with magnets** for simple maintenance and cleaning.
- Possibility of **integration** with temperature control systems.



    <sup>[\*]</sup>

<sup>[\*]</sup> presently available only in Italy / Italian language.





Products aren't just connected, they are interconnected through a smart app for the entire house.

ECOCOMFORT 2 SMART is the MEV device featuring artificial intelligence that allows you to measure and control the air quality, and at the same time manage ventilation in the home, adapting to the user's preferences for optimal comfort without wasting energy, even in cases where large ventilation systems are not possible or necessary.

Along with traditional comfort, multicomfort also introduces the aspect of connectivity, that is, the option of remote room control through smart home instruments and devices.

Thanks to Fantini Cosmi smart home solutions not only can you monitor temperature and air quality, but you can also change them as needed. The *Intelliclima+* App is an actual "hub" that you can use to also configure and manage all the Fantini Cosmi IoT devices in the home from an "integrated" smart home perspective.

Therefore, when the multi-comfort system is integrated with the *Intelliclima+* App, the system is always connected and it is possible to manage one's ideal comfort from anywhere in a simple and intuitive way, from smartphone and tablet.

## EASIER TO CONFIGURE

ECOCOMFORT 2 SMART is configured and managed, locally via Bluetooth Low Energy (BLE) or remotely via WIFI, through the *Intelliclima+* App, which thus becomes an actual "hub" used to configure all of the Fantini Cosmi programmable thermostats in the house, with a view to an "integrated" smart home.

## SINGLE-ROOM AND MULTI-ROOM

The ECOCOMFORT 2 SMART spot ventilation units can be used as a **spot system** in each single room, or by connecting multiple ventilation units to a single command, to create a **multi-room ventilation system**.

The minimum installable configuration is the "Master" unit, to which several additional units can be added. All of the units communicate with each other through the Bluetooth Low Energy protocol and will be managed through the *Intelliclima+* App. The additional units can be installed in large rooms or in other spaces.

Through the *Intelliclima+* App it is possible to manage other ventilation units in combined mode, adjust fan speeds, manage the air extraction/intake functions and allow AUTO SMART SENSOR automatic cycle adjustment.



MASTER UNIT



ADDITIONAL UNITS



ADDITIONAL UNITS



ADDITIONAL UNITS



ADDITIONAL UNITS

1ST LEVEL  
CONFIGURATION

2ND LEVEL  
CONFIGURATION

## EASIER TO INSTALL

The cover is attached with magnets to simplify installation and maintenance operations, while offering a neater look.

Plus, the decentralised system solutions are particularly offer easy and fast to install, in fact they have the characteristics of being **ready for use and do not require additional air distribution systems** (pipes and fittings), neither in air intake, nor in ejection, as **they are installed directly on the external wall**.

TELESCOPIC TUBE FOR QUICK INSTALLATION  
MINIMUM LENGTH 28 CM MAXIMUM LENGTH 53 CM

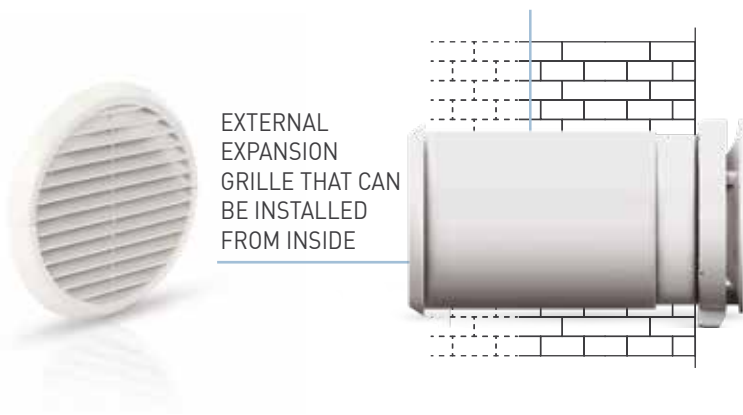

The ECOCOMFORT 2 SMART ventilation unit must be installed on the external walls.

Thanks to the telescopic tube **it adapts easily to all wall thicknesses**, from a minimum of 28 cm to a maximum of 53 cm. In addition, it is extremely easy and quick to install, also thanks to the external expansion grate, which may be fitted from inside.

## MAIN STEPS



**1**  
Make an opening  
in the external wall



**2**  
Insert the  
telescopic tube at  
the desired length



**3**  
Insert the  
expansion  
grate from  
inside the  
room



**4**  
Insert the cartridge  
complete with  
motor and ceramic  
heat exchanger



**5**  
Secure the support  
base to the wall  
and connect  
the unit to the  
electrical line

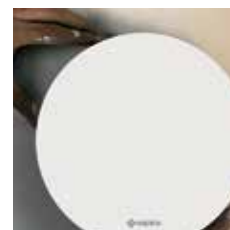

**6**  
Attach the  
cover

# MEV TURNS SMART

Discover the new ventilation that adapts to your preferences.

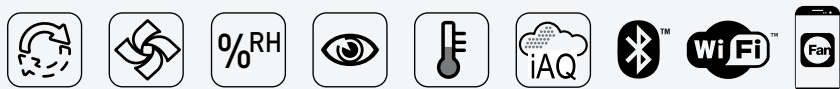

ECOCOMFORT 2 SMART is a ventilation and extraction unit with "smart" functions for an innovative approach to the management of environmental comfort.

Thanks to **the continuous monitoring of environmental parameters** (such as VOC and humidity) and the processing of data by "Artificial Intelligence" algorithms, the system crosschecks all the information useful to optimise use of the ventilation system of the rooms, anticipating or delaying activation also based on advanced dynamic geolocation of the user with the purpose of providing the best thermo hygrometric comfort conditions with the lowest possible consumption.

Meanwhile, the **Dynamic Geolocation** function adaptively calculates the actual time that people take to come home/leave the house. In this way, ECOCOMFORT 2 SMART allows you to modulate the set preferences to avoid unnecessarily wasting energy when you are away from home, and guaranteeing maximum comfort when you are at home.



## PERCEIVED TEMPERATURE

ECOCOMFORT 2 SMART regulates comfort, also considering the humidity parameter in addition to temperature.



### **DYNAMIC GEOLOCATION**

ECOCOMFORT 2 SMART adaptively calculates the actual time you take to come home and leave the house, avoiding wasting unnecessary energy when you are not at home.



### **COMFORT WITH FULL PEACE OF MIND**

The temperature, humidity and brightness sensors allow the unit to adopt the most suitable ventilation mode entirely autonomously and ensure the best level of comfort in the room.



### **FREE COOLING**

In summer - when the external temperature is lower than the internal one - the function helps to ensure greater thermal comfort while recovering efficiency.

# THE MEV WITH ARTIFICIAL INTELLIGENCE

Also controls **air quality**.

The Indoor Air Quality (IAQ) depends on several factors which can now be objectively detected thanks to available technologies.

ECOCOMFORT 2 SMART is the smart spot ventilation unit that also controls air quality.

In fact, thanks to internal sensors that are able to measure the **relative humidity** (RH%) and the **volatile organic compounds** (VOC), ECOCOMFORT 2 SMART constantly monitors the indoor air quality and thanks to the use of Artificial Intelligence, at the same time it is also able to independently manage ventilation in the home by providing air recirculation only when necessary, while still adapting to the user preferences to bring well-being and excellent comfort to your smart home without wasting energy.



In this new evolved ventilation approach, the AUTO SMART SENSOR function translates into a lower primary energy requirement that can be verified and consulted by the user, through the infographics sections of the *Intelliclimate+* App which display the trend in system consumption and the parameters read by the sensors on the device: Room temperature, Ambient humidity and Air quality.



### **INDOOR AIR QUALITY SENSORS**

In Aspira ventilation systems, the relative humidity (RH%) and the concentration of volatile organic compounds (VOC) is constantly monitored by the on-board sensors of the device which, based on the values detected, adjust the fresh air flow rate according to real needs.



# LOOK WHO'S TALKING

Comfort is also managed  
with your voice. <sup>(\*)</sup>



Are you lying comfortably on the sofa and would like to change the comfort settings, but don't want to get up?

With ECOCOMFORT 2 SMART you can ask your **Amazon Alexa™** smart speaker to do it for you! <sup>(\*)</sup>



Everything becomes easy, just like having an actual personal assistant ready to fulfil your requests. In fact ECOCOMFORT 2 SMART allows you to manage your system remotely from **Amazon Alexa™** smart speaker. <sup>(\*)</sup>

<sup>(\*)</sup> presently available only in Italy / Italian language.





Thanks to the voice interface, the user is free to manage the device and its functions by saying simple command phrases without having to go through the device or the *Intelliclimate+* App, but comfortably seated on the sofa or while doing other household chores, ECOCOMFORT 2 SMART will respond to commands without the need for any manual intervention thus obtaining even more comfort and well-being.

[\*]

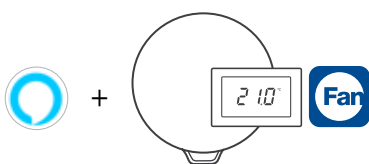

The user must have Amazon Echo™ and a compatible Fantini Cosmi device with the *Intelliclimate+* App. Once you have configured the appliance, you can use the voice commands directly with xAmazon Alexa™ to control the ventilation system. [\*] You can continue to use the *Intelliclimate+* App for remote control. [\*]

### IN JUST A FEW WORDS...

Asking for **information about the system** and **changing operating mode** of the ventilation system is truly simple! Here are a few practical examples: to the question "What is the air quality?" ECOCOMFORT 2 SMART can reply: "In the living room the air quality is excellent. In bedroom 3 the air quality is excellent..."

You can also **change the operating speed** like this: "Ecomcomfort set the maximum speed in the bathroom". Reply: "In the Bathroom your Ecomcomfort has been set to the maximum speed and manual mode."

Or **even simpler**: "Turn on Ecomcomfort".

# Intelliclimate+

## ALWAYS CONNECTED ANYWHERE

Products aren't just connected, they are interconnected through a smart App for the entire house.



The ECOCOMFORT 2 SMART multi connectivity system integrates with the *Intelliclimate+* App, an actual "hub" used to configure and manage not only your ventilation system, but also all of the Fantini Cosmi programmable thermostats in the house from an "integrated" smart home perspective.

In fact ECOCOMFORT 2 SMART supports the **WiFi** and **Bluetooth Low Energy (BLE)** technologies that are able to make configuration and management easier, and uses artificial intelligence algorithms to improve air quality and personal well-being.

Thanks to control through the *Intelliclimate+* App you're always connected to your system and you can manage your ideal comfort levels in a simple and intuitive way, from a smartphone or tablet, wherever you may be.



Discover the  
**#Multicomfort** system  
to manage your ideal  
comfort in a simple  
and intuitive way,  
wherever you are.

#### WHY SWITCH FROM TRADITIONAL COMFORT TO **FANTINI COSMI #multicomfort?**

First of all, to have better air conditioning control and improve the health of the residents. Then, because full control of every room leads to a set of side benefits.

Using smart solutions for something like ventilation, for instance, allows you to recover heat while renewing air. This assures high comfort levels also in 'challenging' rooms or rooms that would not reach the same high levels of comfort under normal conditions.

But that's not all: Multicomfort is also a healthy and green choice, because it optimises consumption and minimises the need to heat or cool rooms more than necessary.

## GUIDED INSTALLATION

You can use an installation wizard to configure the App and your programmable thermostat in just a few simple steps.

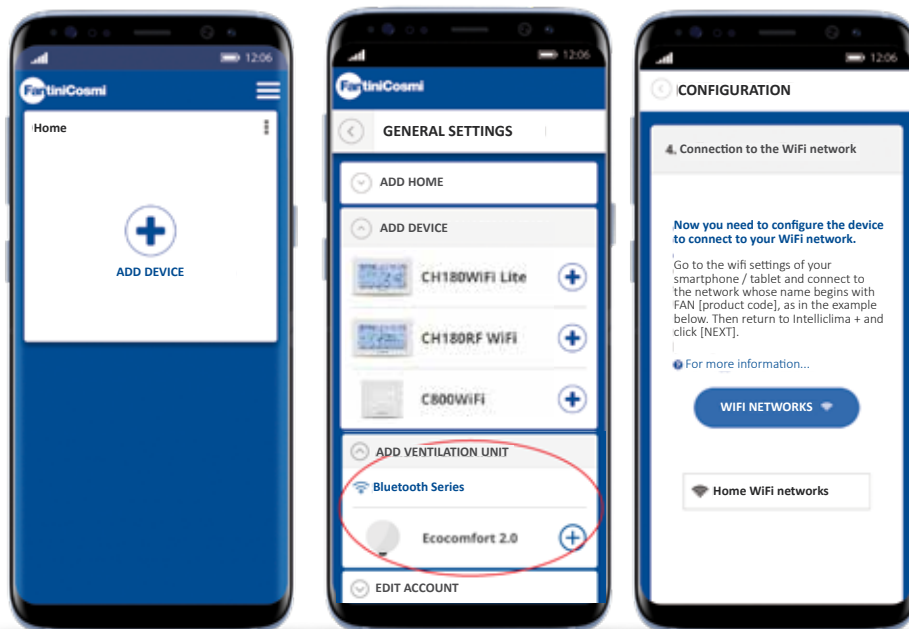

The **Intelliclimate +** App is available for free on:



## CHOOSE YOUR COMFORT

Use the *Intelliclimate+* App for all your devices, at home or in the office, beach side or mountain side.

In fact, *Intelliclimate+* can control several homes and several ventilation units and programmable wifi thermostats within a single home.

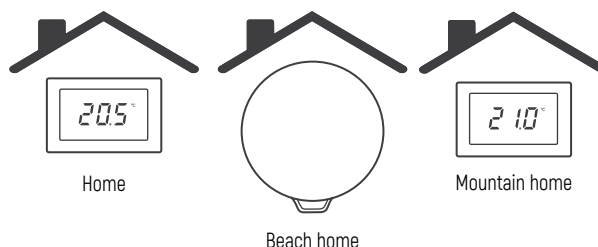

## SIMPLE AND INTUITIVE GRAPHICS

The graphic interface is intuitive and allows the user to set and modify the various operating modes, as well as to check current settings from anywhere in the room.



## PRESET PROGRAMMES

Start using your programmable thermostat immediately with the programmes; *Intelliclimate+* provides you with useful preset programming profiles that will help you program and manage your comfort.

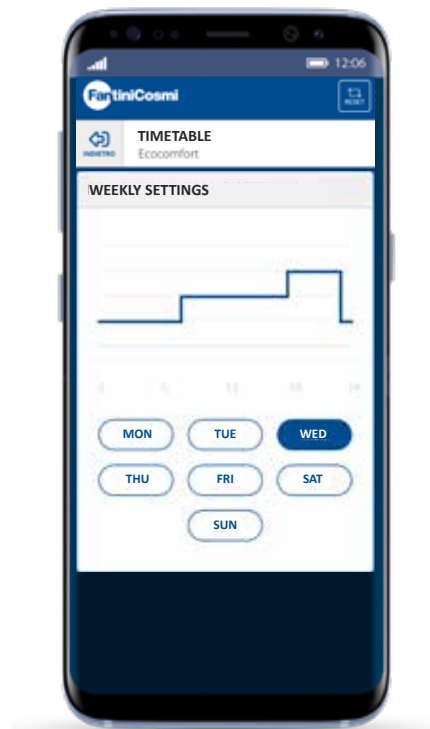

## REPORTS

View the data of Temperature, Relative Humidity, VOC and Speed recorded by ECOCOMFORT 2 SMART on a daily, weekly or monthly basis.



## DYNAMIC GEOLOCATION

Set different ECOCOMFORT 2 SMART speeds based on your position in relation to the device.

ECOCOMFORT 2 SMART adaptively calculates the actual time you take to come home and leave the house, avoiding wasting unnecessary energy when you are not at home.

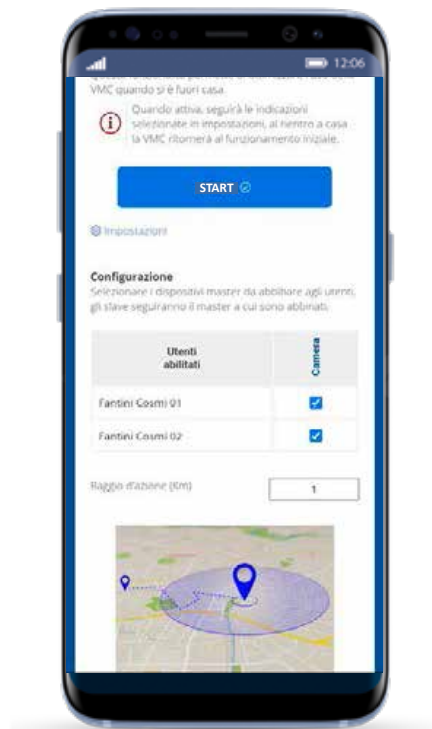



## CONTROL AND SHARE

The *Inteliclima+* App lets you share programmable thermostat control with any users of your choice.

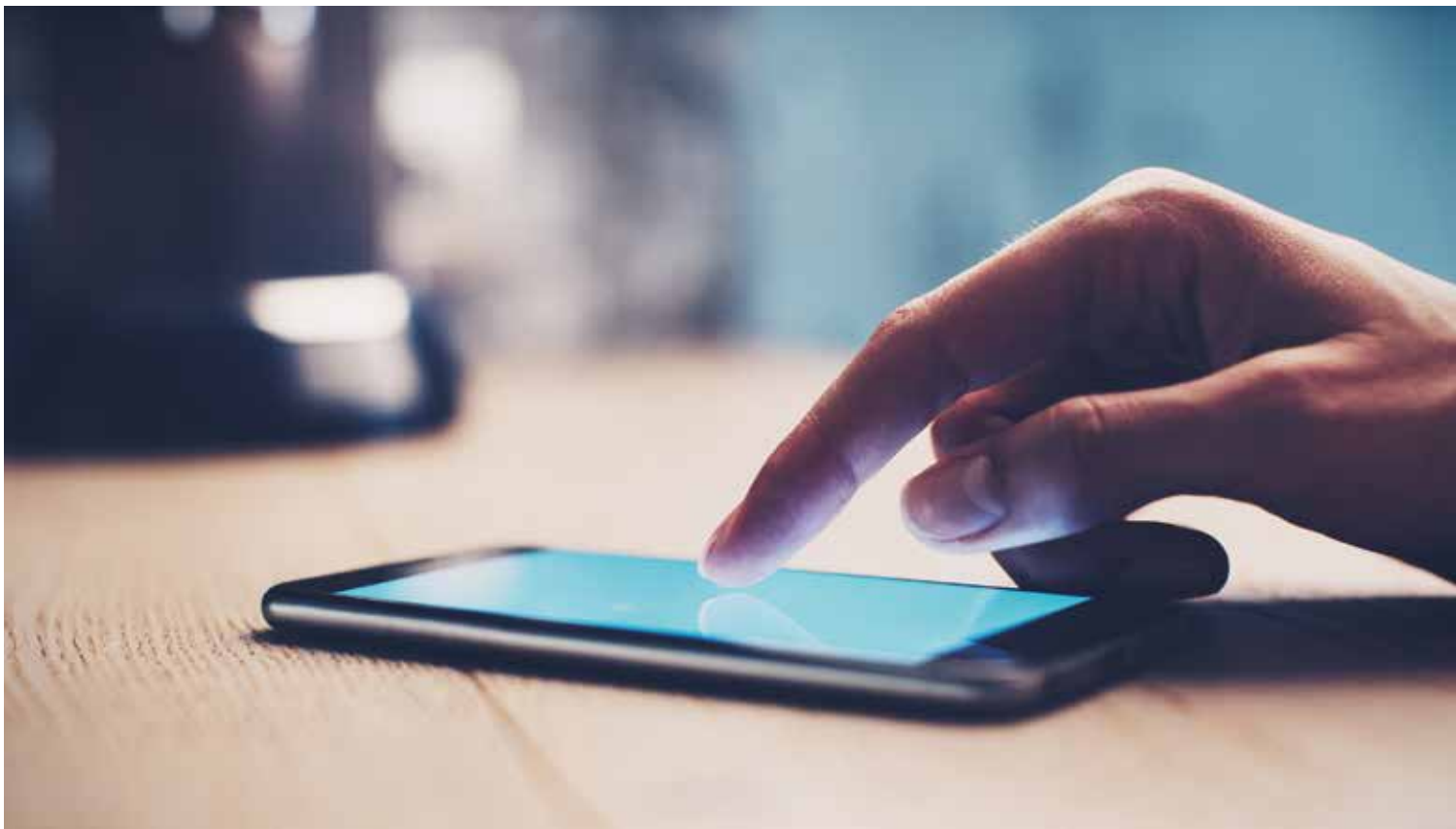
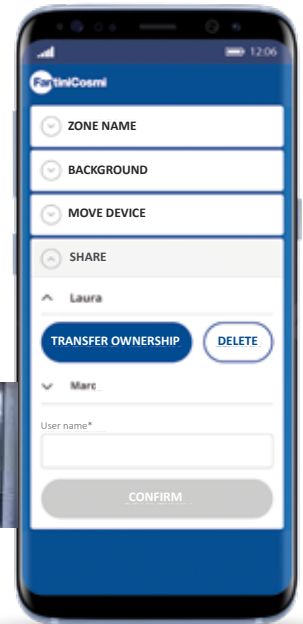

# ECOCOMFORT 2 SMART



Decentralised ventilation and extraction unit with very high efficiency heat recovery, air quality control and smart functions

ECOCOMFORT 2 SMART is a ventilation and extraction unit with heat recovery and "smart" functions for an innovative approach to the management of environmental comfort. Thanks to the continuous monitoring of environmental parameters (such as VOC and humidity) and the processing of data by "Artificial Intelligence" algorithms, the system crosschecks all the information useful to optimise use of the ventilation system of the rooms, anticipating or delaying activation also based on advanced geolocation of the user with the purpose of providing the best comfort conditions with the lowest possible consumption.

The minimum installable configuration is the "main" unit, to which several "satellite" units can be added.

The ECOCOMFORT 2 SMART multi connectivity system integrates with the *Intelliclimate+* App, which is used to configure and manage not only the different operating modes of the fan system, but also Fantini Cosmi smart programmable thermostats from an "integrated" smart home perspective.



The *Intelliclimate+* App is available for free on:



<sup>(\*)</sup> presently available only in Italy / Italian language.

## HOMOLOGATION AND STANDARDS

- Compliant with Directive 2014/53/EU (RED);
- Compliant with Directive 2009/125/EC Energy Related Products (ERP) – Ecodesign 2018;
- Compliant with Regulations: EN 60335-1:2013+A11:2015; EN 60335-2-80:2005+ A2:2009;
- EN 55014-1:2006+A1:2009+A2:2011; EN55014-2:2015; EN61000-3-2:2014; EN61000-3-3:2013
- EN301 489-1 V.1.9.2; EN301 489-7 V.1.3.1
- ETSI EN300 220-1 V2.4.1; ETSI EN300 220-2 V2.4.1
- UNI EN ISO 10140-2 – UNI EN ISO 717-1





## TECHNICAL FEATURES

Code	AP19992
Model	ECOCOMFORT 2 SMART
Ø DN TUBE	160 mm
Power supply	230V~ 50Hz
Room relative humidity display scale	0 - 99%, increase 1%
No. Programs/ Operating speed	5 Programs / 4 Speeds

## DIMENSIONS

FAN WITH RECOVERY UNIT

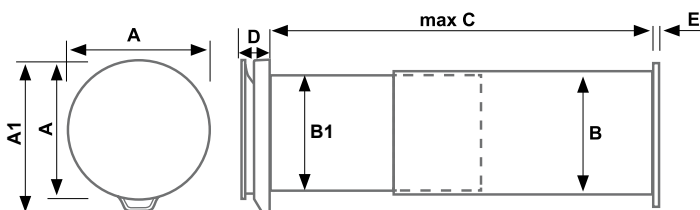

OUTDOOR GRILLE  
FOLDABLE

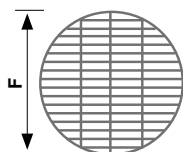

A	A1	B	B1	C	D	E	F
230	250	162 (Ø OD)	158 (Ø OD)	280 ÷ 530	55	20	190
		159 (Ø ID)	155 (Ø ID)				

## GENERAL SPECIFICATIONS

- Control from App on iOS and Android devices.
- Bluetooth Low Energy and WIFI communication system
- Weekly programming of operation and possibility of voice control with Amazon Alexa™ smart speakers. (\*)
- Temperature, relative humidity, brightness and VOC sensors.
- Smart and Summer Free-Cooling functions
- External wall-mounting in rooms up to 36 sqm\*
- Regenerative ceramic heat exchanger of up to 90% high efficiency, with tear proof removal handle.
- Very low noise level
- Anti UV and antistatic ABS plastic;
- Telescopic tube suited for all wall thicknesses;
- Flexible outdoor grille for internal or external type of installation;
- Filter class ISO Coarse in accordance with UNI EN ISO 16890:2017;
- Thermal and acoustic insulation panel to obtain low noise levels and avoid the formation of condensation.
- Flow rectifier for higher performance;
- Facade insulation (D2mnTw) 40dB\*\*
- IPX4 protection rating.
- Remote FW update through APP
- Possibility of integration with temperature control systems.

\* information calculated on: air exchange equal to 0.5 Vol/h and local height 2.70 metres. By increasing the number of slave units it is possible to increase the coverage in square meters.

\*\* Reduction of noise from outside with kit code AP19881 (in compliance with the Minimum Environmental Criteria for acoustic comfort).

(\*) presently available only in Italy / Italian language.

## PERFORMANCE DATA

SPEED	m <sup>3</sup> /h	MAX ABSORBED POWER	dB(A) 1.5 m
low	20.5	2.5 W	18.5
medium	35	4 W	26.5
high	48.5	6.3 W	32.5
sleep	8	2	n/a

## OPERATION

### ■ Manual mode setting:

in this mode it is possible to choose the setting of the operating speeds



V3 - high speed;



V2 - medium speed;



V1 - low speed;

and the operating mode setting:



air supply (60 min. temporary mode)



air extraction (60 min. temporary mode)



alternate supply/extraction flow with 45 sec cycles



the main ventilation unit automatically regulates the intake/extraction flow alternating time and speed, according to the room parameters read by the temperature, humidity and light brightness sensors.

### ■ SLEEP mode setting



setting at minimum operating speed

### ■ AUTO mode setting

In AUTOMATIC mode, ECOCOMFORT 2 SMART works according to the schedule profiles set in PROGRAMS, following an alternating air supply/extraction flow with 45 sec cycles. The speeds can be changed according to the room parameters read by the temperature, humidity, VOC and brightness sensors.

## ACCESSORIES AND SPARE PARTS

CODE	MODEL
AP1984	FR007 - Filters class ISO Coarse in accordance with UNI EN ISO 16890:2017
AP1985	FR008 - Panel for sound, thermal and anti-condensation insulation
AP1612	GAP 150 - Rainproof/windproof grille for ECOCOMFORT Ø160 mm models
AP19881	SLF160 - Outdoor noise reduction kit



The features referring to the equipment in this catalogue are not binding. The company Fantini Cosmi S.p.A. reserves the right to make changes without prior or public notice for technological improvement, regulatory evolution and commercial matters, without prejudice to the main functional features of the models.



FANTINI COSMI SPA Via dell'Osio, 6 - 20049 Caleppio di Settala MI, Italy  
Tel. +39 02 956821 | Fax +39 02 95307006 | [info@fantinicosmi.it](mailto:info@fantinicosmi.it)

EXPORT DEPARTMENT  
Ph +39 02 95682229 | Fax +39 02 95307006 | [export@fantinicosmi.it](mailto:export@fantinicosmi.it)

[www.fantinicosmi.com](http://www.fantinicosmi.com)

