



C800WIFIOTRQ

EN

OPEN THERM® REMOTE CONTROL WITH SMART FUNCTIONS
FOR HEAT GENERATORS

FULL INSTALLATION, CONFIGURATION AND USE MANUAL

Thank you for purchasing a **C800WIFIOTRQ** product.

Read this instructions manual carefully and always keep it handy for any consultation.

The documentation reflects the characteristics of the product; however due to regulatory or commercial changes, customers are advised to check the availability of updates to this documentation on the C800WIFIOTRQ website : **pdf.fantinosmi.it**; frame the QR-code to be taken directly to the link.



SUMMARY

1 - TECHNICAL DATA	2	4 - ERROR STATUS REPORTING	20
2 - INSTALLATION	4	5 - USE FROM APP	20
2.1 - POWER SUPPLY.....	4	5.1 - APP INSTALLATION	21
2.2 - CONNECTION TO THE SYSTEM	7	5.2 - SYSTEM CONFIGURATION.....	22
2.3 - WALL FASTENING	9	5.3 - PROGRAMMING VIA APP.....	26
3 - USE FROM DEVICE	11	5.4 - DEVICE SETTINGS	29
3.1 - SWITCHING ON THE DISPLAY	12	5.5 - HOME SETTINGS	52
3.2 - OPERATING MODE SELECTION	12	5.6 - GENERAL APP SETTINGS	53
3.3 - CHANGING THE TEMPERATURE.....	15	6 - DISPOSAL	55
3.4 - BASIC FUNCTIONS.....	15	7 - GENERAL WARRANTY CONDITIONS	55
3.5 - ADVANCED FUNCTIONS.....	18		
3.6 - OVERVIEW OF MAIN EDITABLE FUNCTIONS.....	20		

1 - TECHNICAL DATA

Power supply	2 AA 1.5 V alkaline batteries 230 V - 50 Hz (Power Supply C800AL)
Battery life	> 1 year
Adjustment	OpenTherm
Max. mains power consumption	1 W
LED switch-off	5 ÷ 10 s from last press
Temperature adjustment scale	2 to 40 °C; increase 0.1 °C
Room T scale measurement/display	-9 to +50 °C; resolution 0.1 °C
Temperature display	Celsius/Fahrenheit
Nominal conductor cross-section for flexible cables	0.5 to 1 mm ²
Adjustment differential	STD (0.1 to 0.3) °C
Reference thermal gradient	4 K/h
Maximum room temperature	45°C
Storage temperature	-10 to +60°C
Software	Class A
Insulation class	Class II
Protection rating	IP32
Degree of pollution	2
Assembly	On the wall or on a flush-mounted box type 500-502-503
Remote control dimensions	98 x 98 x 20 mm (square base) 125 x 98 x 20 mm (rectangular base)
C800AL power supply unit dimensions	43 x 43/48 x 35 mm
Weight	0.100 kg

Compliant with standards: EN 60730-1 and second parts;

Directive 2014/53/EU (RED); 2014/30/EU (EMC); 2014/35/EU (LVD)

ErP classification (Reg. EU 811/2013 - 813/2013): V; 3% or VI; 4% when combined with boiler with external probe.

Product manufactured in Italy.

2 - INSTALLATION



Installation and maintenance operations must be carried out with the system's electrical voltage switched off and by qualified personnel, in compliance with the regulations in force.

2.1 - POWER SUPPLY

Separate the front cover from the base by pressing the button on the bottom edge of the cover and releasing the housing upwards as shown in the figure.

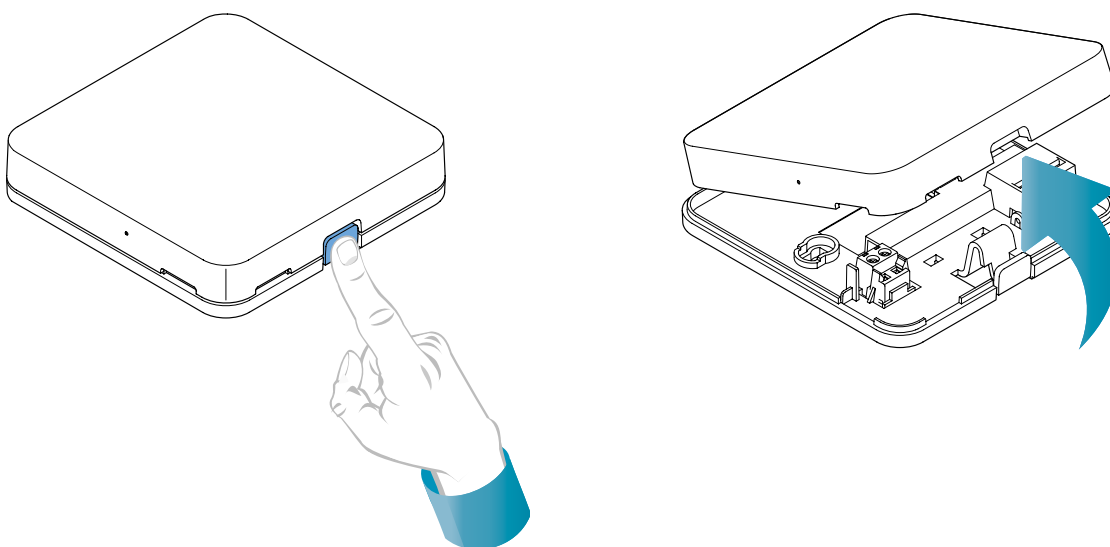

BATTERY POWER SUPPLY

To power the device with batteries, use 2 AA 1.5V alkaline batteries.

Insert the batteries in the battery compartment at the rear of the device, observing the indicated polarities.

Notes: If the device is powered by 230V mains, do not insert batteries.

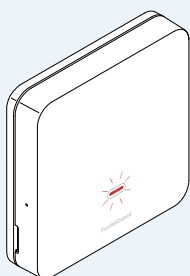
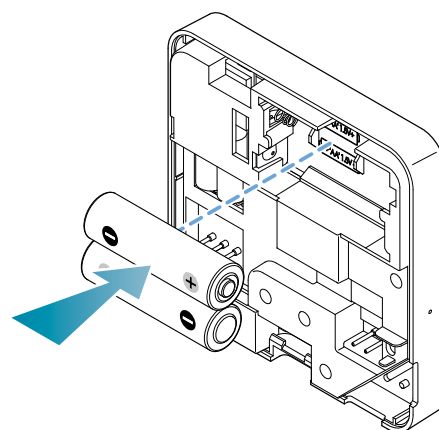

LOW BATTERY WARNING

- **1 flash per minute on display in Stand-by:** the batteries are running low; it is still possible to operate the device but they need to be replaced.
- **1 flash per minute and the display reads "Low Bat" in Stand-by:** the batteries are dead, the device can no longer be operated and will go into OFF.

Batteries can be replaced at any time without losing the stored settings.

MAINS POWER SUPPLY 230V - 50Hz

It is possible to power the device using the C800AL power supply (optional), which requires flush-mounting.

Unscrew the screw as shown in the drawing and lower the plastic cover to gain access to the terminal block for electrical connections.

Note: Use the square base for flush mount box type 500 and 502; rectangular base for flush-mounting box type 503 (see also page 11).

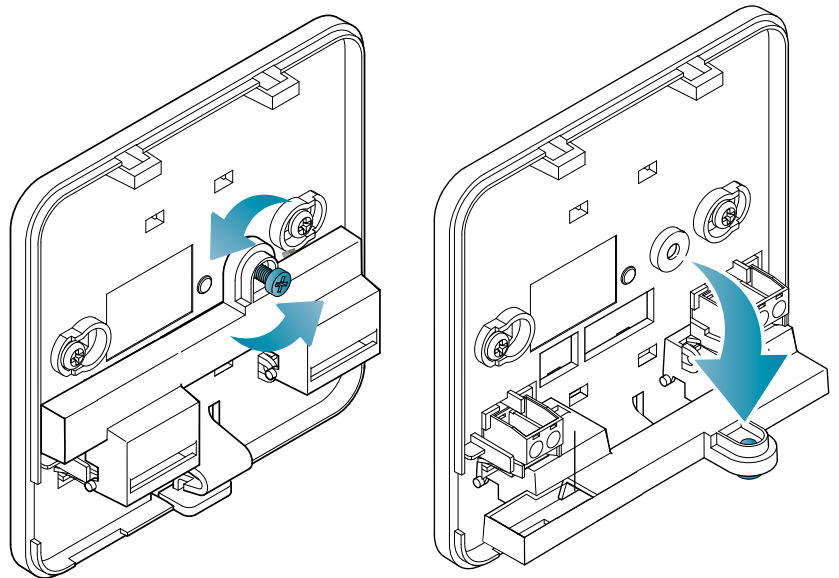

Insert the cables coming out of the C800AL power supply unit to the base of the C800WIFIOTRQ.

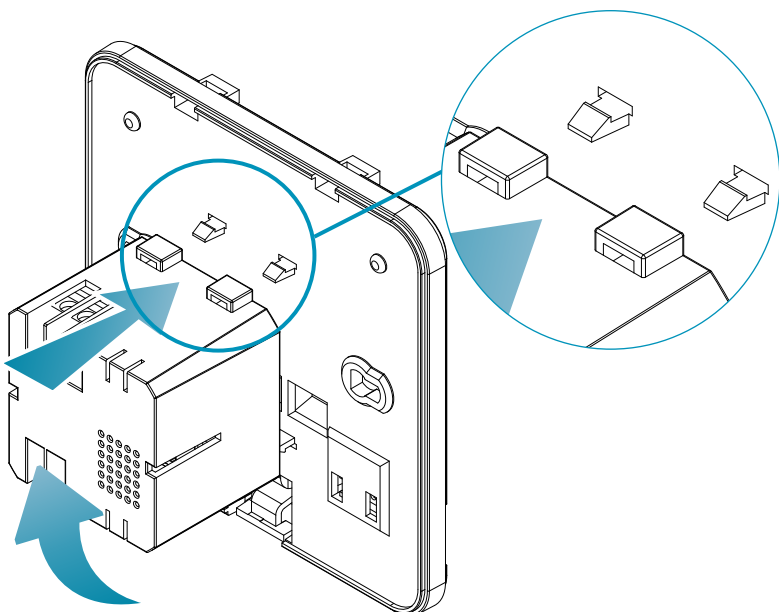
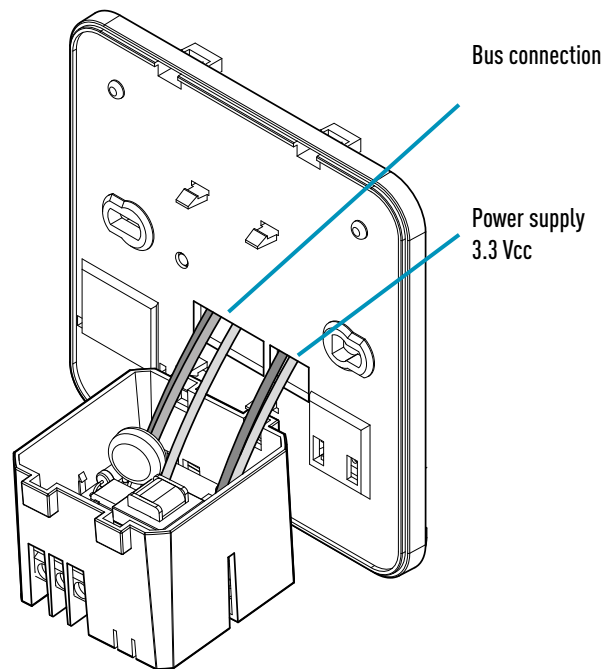

Hook the C800AL onto the 4 tabs of the base, making sure that the fixing is secure.

Connect the cables to the terminal block as shown in the table.

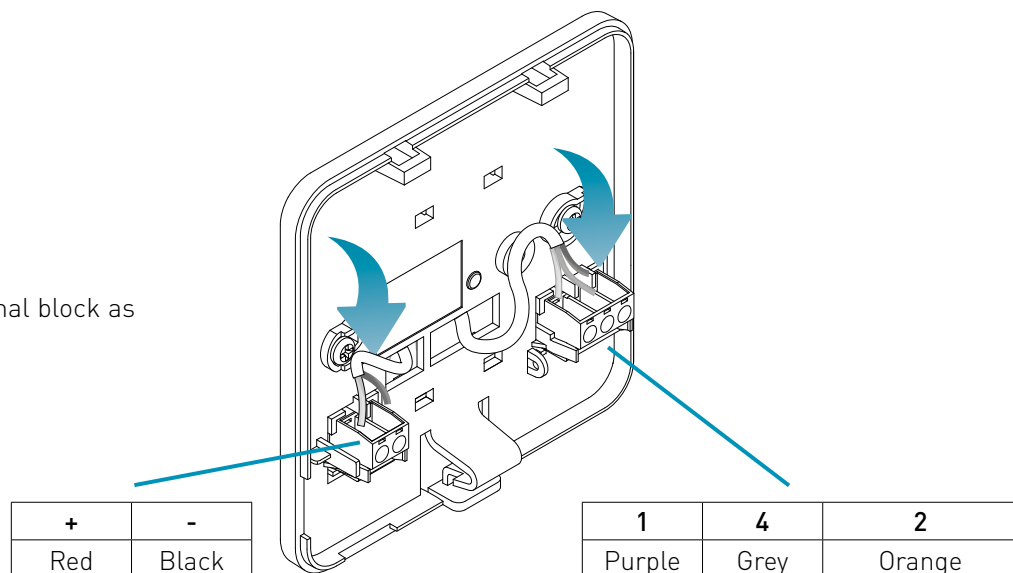

Close and screw on the terminal box cover.

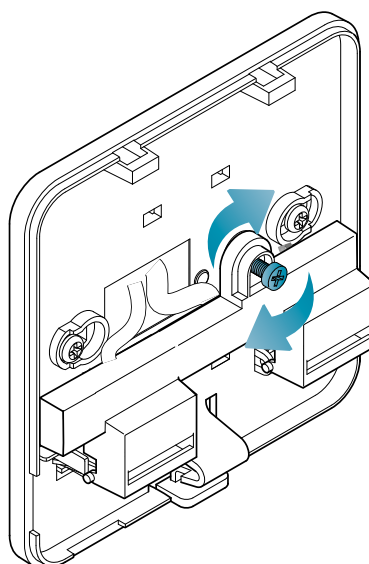

2.2 - CONNECTION TO THE SYSTEM



Installation and maintenance operations must be carried out with the system's electrical voltage switched off and by qualified personnel, in compliance with the regulations in force.

For correct installation, prepare a dedicated line for the remote control bus connection.

CONNECTION WITH BATTERY POWER SUPPLY

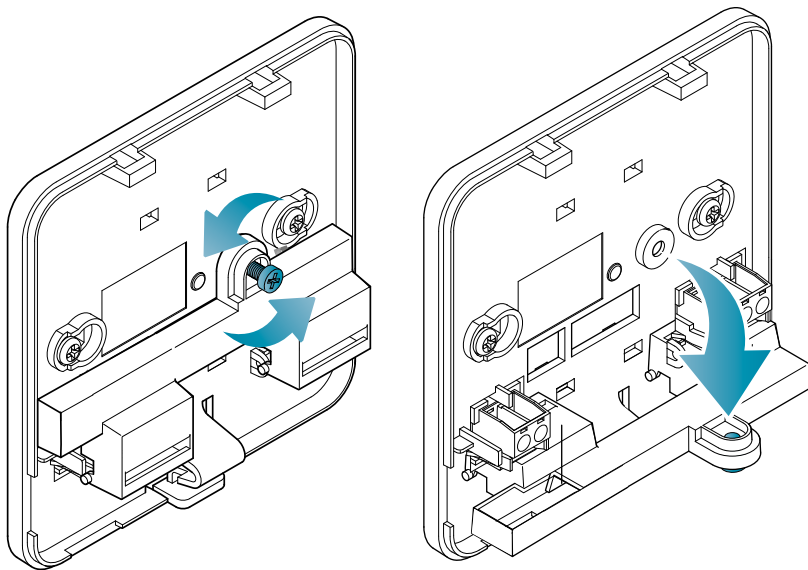

Unscrew the screw as shown in the drawing and lower the plastic cover to gain access to the terminal block for electrical connections.

Connect terminals 2 and 4 to the heating system.

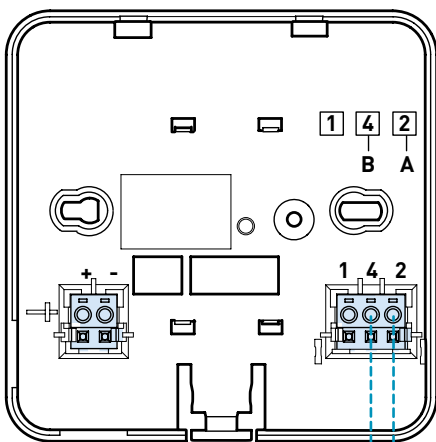

Bus cable length
max. 20m

4: Boiler input contact
2: Boiler input contact
1: Not used

Connection example



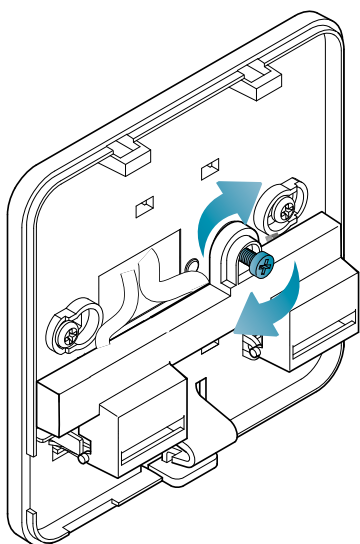

Close and screw on the terminal box cover.

CONNECTION WITH 230V - 50HZ MAINS SUPPLY

If supplied with 230 V, connect the terminals of the C800AL to the electrical and heating system as follows:

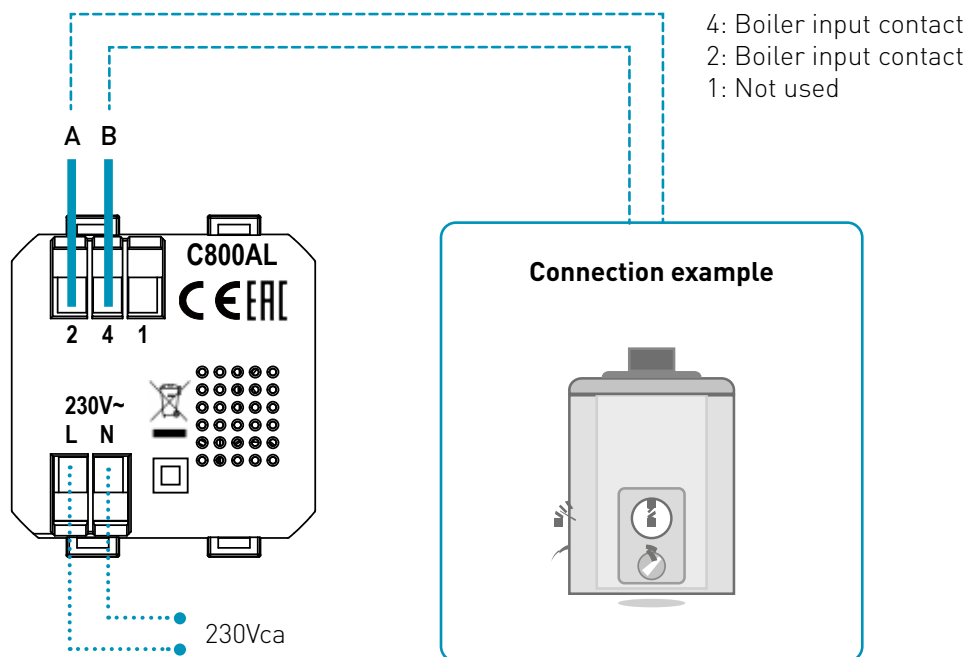

2.3 - WALL FASTENING

For optimal operation of the unit, it is advisable to install the remote control at a height of approx. 1.5 m above the floor, in a suitable position to correctly detect the room temperature (see example in the drawing).

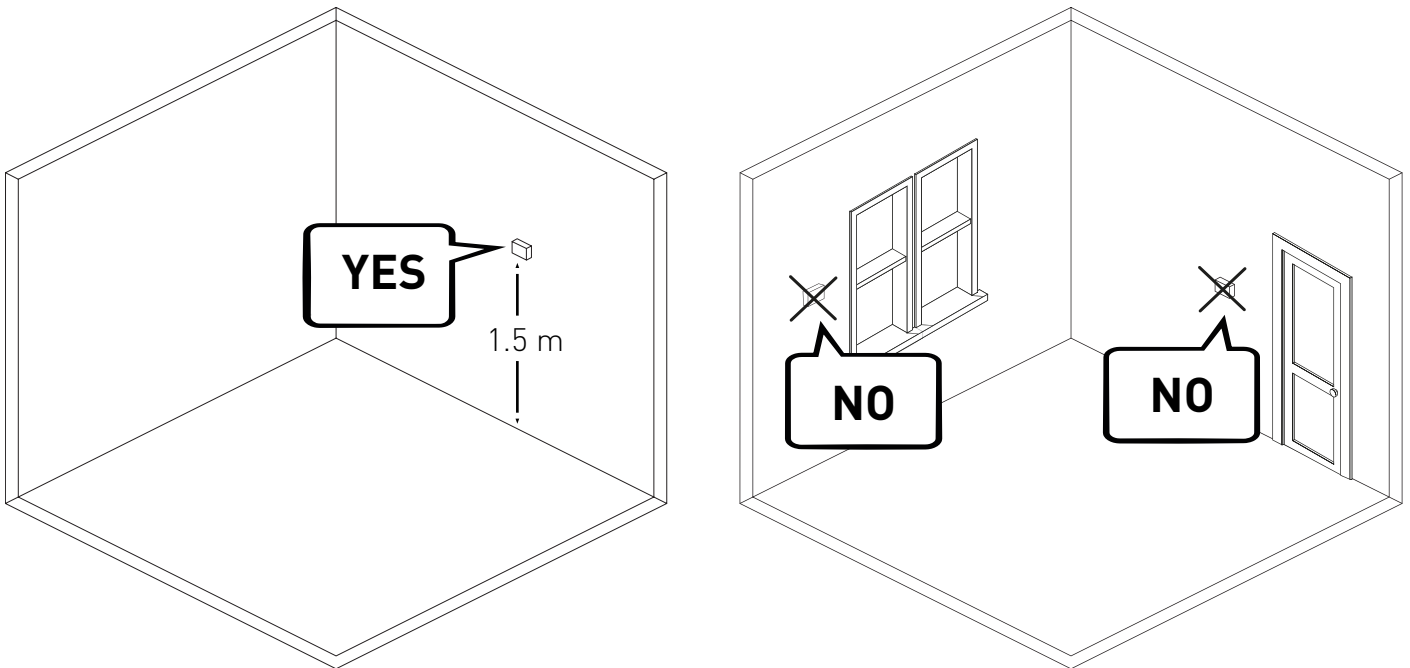

WALL MOUNTING (only with battery power)

The tabs on the back of the base must be removed for wall mounting. In this way, the remote control will be properly adhered to the wall.

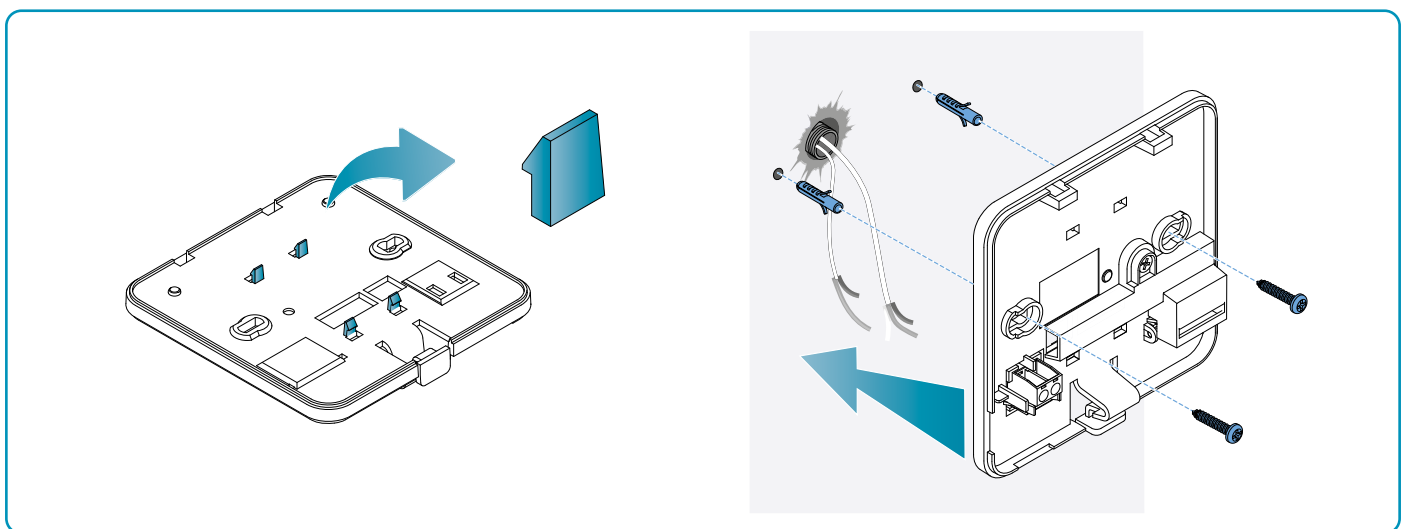

FIXING ON FLUSH-MOUNTED BOXES

The remote control is supplied with a square and rectangular base to allow fixing on flush-mounted boxes type 500-502-503.

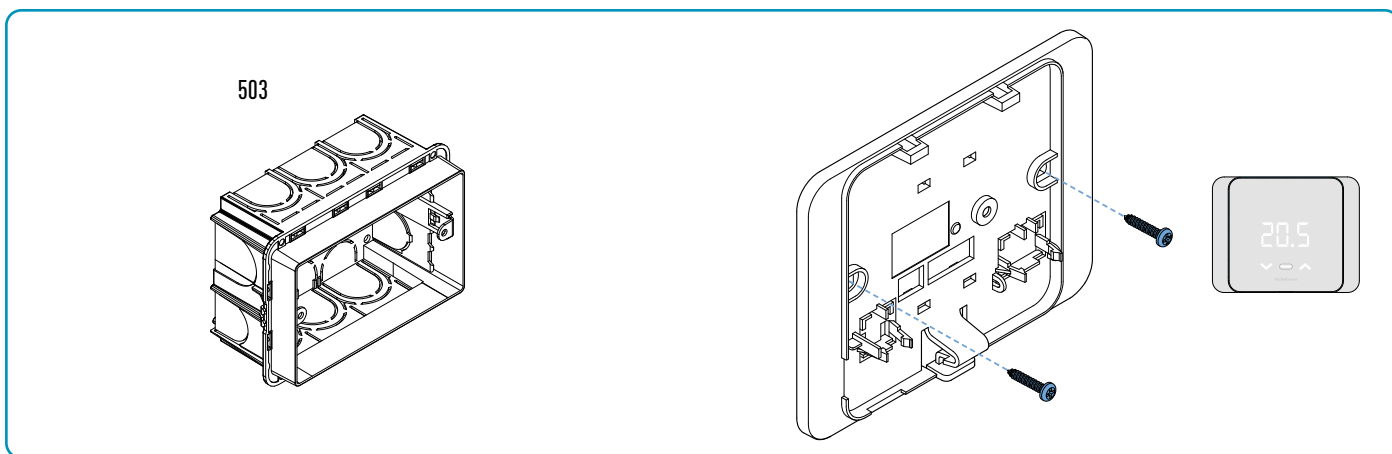
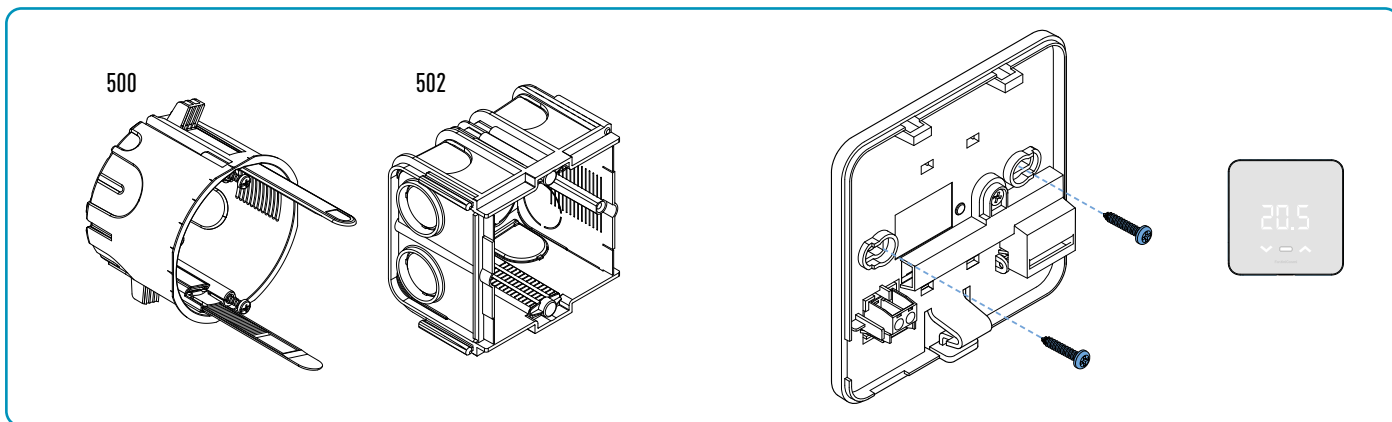

Reattach the front cover.

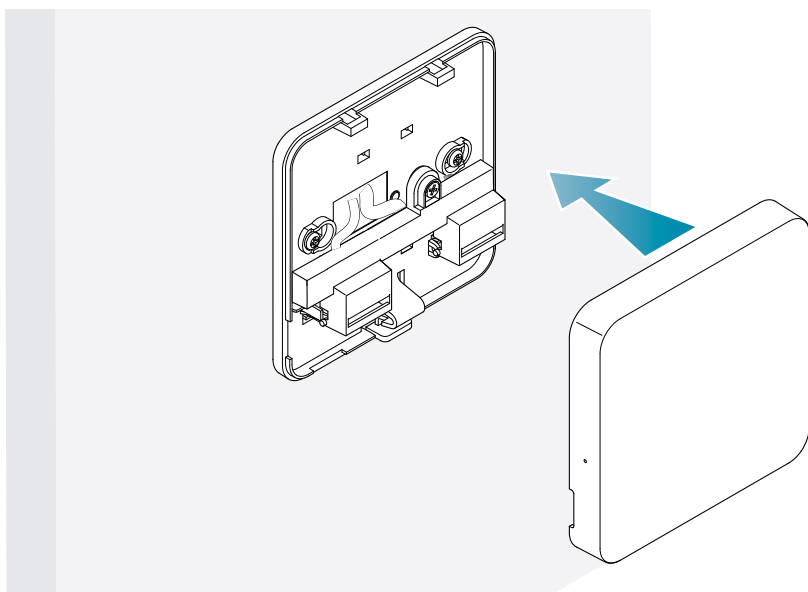

It is now possible to re-energize the system.



When switching on for the first time, wait for the device to communicate with the boiler. When the display LEDs switch off, the device is ready.

3 - USE FROM DEVICE

From the device it is possible to select the type of heating system regulation, the desired operating modes and current temperatures and to activate and modify domestic hot water management.

To customise the programming and temperatures of the heating system, you need to associate the device with the *Intelliclimate+* App and proceed with the relevant configuration (see page 25 and/or APP manual on pdf.fantiniCosmi.it).



3.1 - SWITCHING ON THE DISPLAY

When the remote control is in Stand-by the display is switched off.

Press the central **MODE** button until the screen is activated to display the current operating mode and room temperature.

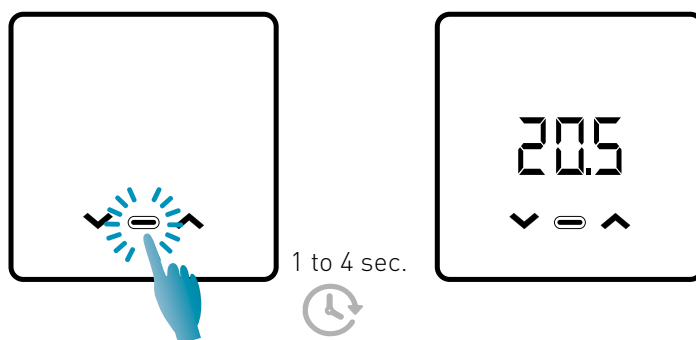

3.2 - OPERATING MODE SELECTION

With the display switched on, press the central **MODE** button again to select the desired operating mode.

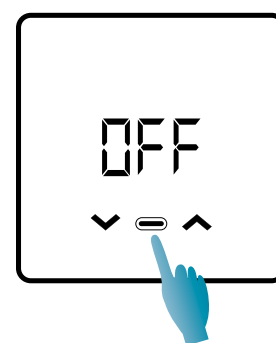

OFF - SHUT-DOWN PROGRAM

In OFF mode, the heating system is switched off. During the WINTER season it maintains the antifreeze temperature, if not disabled (see APP manual on pdf.fantiniCosmi.it).



TA antifreeze adjustable from 2 to 7 °C

MAN - MANUAL PROGRAM

The remote control maintains a fixed temperature, for an unlimited time, until another program is selected.

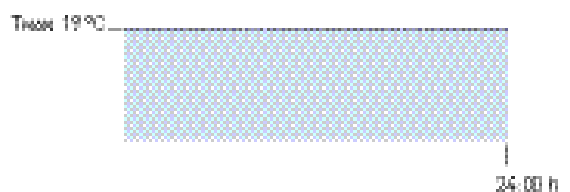

TMAN settable from 2 to 40°C

AUT - "AUTOMATIC" WEEKLY PROGRAM *

The device follows time programs (predefined and user-modifiable; see APP manual at pdf.fantinosmi.it) on weekly profile. It is possible to associate each quarter-hour with one of the three programmable temperatures (off/antifreeze, comfort temperature and economy temperature) for each day of the week.

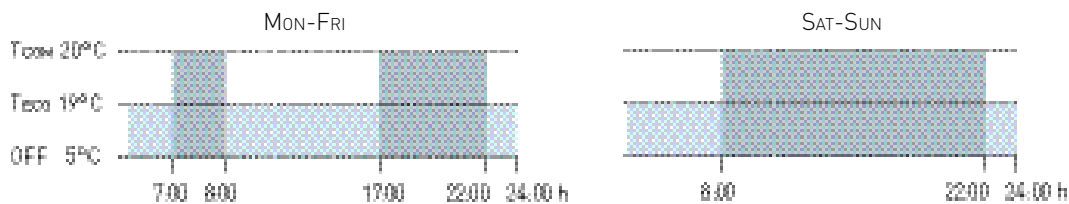

T_{COM} settable from 2 to 40 °C

T_{ECO} settable from 2 to 40 °C

Note: T_{COM} > T_{ECO}

* To use this mode, the current day and time must be set from the user menu (see page 19) or from the App (see APP manual at pdf.fantinosmi.it).

HOL - DAILY "HOLIDAY" PROGRAM *

The device follows time programs (predefined and user-modifiable, see APP manual at pdf.fantinosmi.it) on daily profile. One of three programmable temperatures (off/antifreeze, comfort temperature and economy temperature) can be associated with each quarter-hour. This sequence will be repeated, identically, every day.

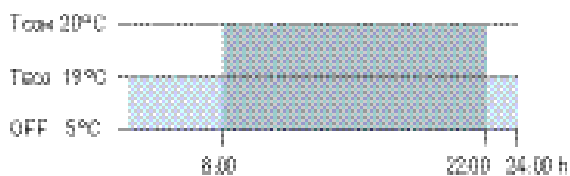

T_{COM} settable from 2 to 40 °C

T_{ECO} settable from 2 to 40 °C

Note: T_{COM} > T_{ECO}

* To use this mode, the current day and time must be set from the user menu (see page 16) or from the App (see APP manual at pdf.fantinosmi.it).

RCS - DOMESTIC HOT WATER PROGRAM (DAILY) **

This function is only available if the boiler board is configured for domestic hot water production management.

If the "DHW" operating mode is enabled (see page 21 - DHW enabling paragraph), during SUMMER or WINTER operation the remote control can also manage a temperature program at certain times of the day for domestic hot water production.

The remote control contains a standard program for managing domestic hot water production that can be freely modified by the user (see APP manual at pdf.fantinosmi.it) so it will be possible to associate one of the two temperature levels with each quarter-hour: T_{COM} and T_{Eco} (comfort and economy temperature).

Accessing this mode from the device, the current T_{COM} / T_{Eco} temperature can be changed temporarily and, the next time the profile band is advanced, it will return to the values originally set. To permanently change the temperature, it is necessary to access the *IntelliClima+* App (see APP manual at pdf.fantinosmi.it).

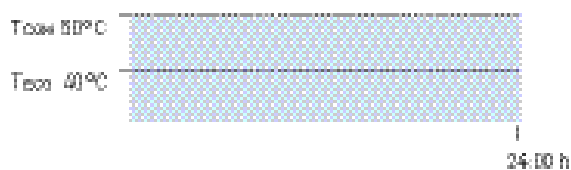

T_{COM} settable according to boiler limits

T_{Eco} settable according to boiler limits

Note: T_{COM} > T_{Eco}

** Mode only visible if activated from the device (see page 18 - DHW Enabling paragraph) or from the App (see APP manual on pdf.fantinosmi.it).

* To use this mode, the current day and time must be set from the user menu (see page 16) or from the App (see APP manual at pdf.fantinosmi.it).

IJL - TEMPORARY "JOLLY" PROGRAM ***

You can choose to maintain a certain temperature for a certain number of hours, after which the system will revert to the previously active program.

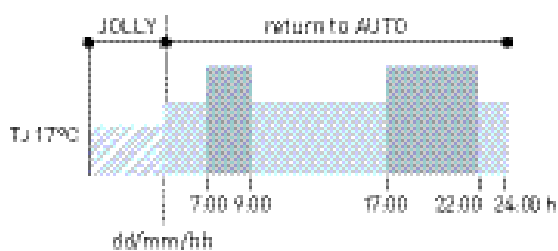

Ij: Settable temperature 2 to 40°C.

Example: Automatic + Jolly at 17 °C for 1 week. At the end of the Jolly period, the remote control resumes operation with an automatic program.

*** Mode only visible if activated from the App (see APP manual at pdf.fantinosmi.it).

Saving of changes is confirmed by a flashing of the last parameter displayed. After saving, the display will return to Stand-by.

3.3 - CHANGING THE TEMPERATURE

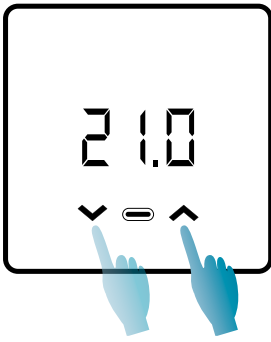

With the display switched on, press the UP or DOWN arrows to change the desired temperature value (Set Point). The value is increased or decreased in steps of 0.1°C.

In AUT, HOL and DHW mode, the temperature change made from the device will be temporary and will revert to the initially set values the next time the profile band is advanced. To permanently change the desired temperature, it is necessary to access the *Intelliclimate+* App (see APP manual at pdf.fantiniCosmi.it).

Saving of changes is confirmed by a flashing of the last parameter displayed. After saving, the display will return to Stand-by.

3.4 - BASIC FUNCTIONS

To change the basic functions, you can access the basic settings menu:

<p>1</p> <p>1 to 4 sec.</p> <p>Press and hold MODE until remote control is reactivated.</p>	<p>2</p> <p>3 sec.</p> <p>Press and hold MODE again for more than 3 seconds.</p>	<p>3</p> <p>Use the central MODE button to scroll through the menu items (see list).</p>	<p>4</p> <p>Use the arrows to change the settings of the selected item.</p>
---	--	--	---

Saving of changes is confirmed by a flashing of the last parameter displayed. After saving, the display will return to Stand-by.

BASIC SETTINGS MENU**RP Access point**

Allows you to start the pairing procedure between device and App (see page 22).
After about 15 minutes, the device will return to the default OFF setting.

Default value = OFF

OFF Access Point disabled

ON Access Point enabled

dRY Current day setting *

Allows you to set the current day required to manage the weekly programming bands (AUT and DHW mode).

Default value at switch-on = 1

Settable values = 1 to 7

1 = Monday; 2 = Tuesday; 3 = Wednesday; 4 = Thursday; 5 = Friday; 6 = Saturday; 7 = Sunday.

h Current time setting (hour) *

Allows you to set the current time required to manage the daily and weekly programming time slots (AUT, HOL and DHW modes).

Default value at switch-on = 00

Settable values = 00 to 23

H n Current time setting (minutes) *

Allows you to set the current time required to manage the daily and weekly programming time slots (AUT, HOL and DHW modes).

Default value at switch-on = 00

Settable values = 00 to 59

F w Firmware

You can see the firmware release version on this screen.

5E E Teco Domestic hot water

It allows you to set the "economy" domestic hot water temperature for a more energy-saving regulation, such as during the night or when you are away for short periods of time.

Default Set Point = 40°C

Settable values = Automatic alignment with boiler limits

Note: T_{COM} > T_{ECO}

* When the device is configured in WiFi, the date and time will be set automatically.

☰ T_{COM} Domestic hot water

It allows you to set the “comfort” temperature of domestic hot water for a regulation adapted to the moments you spend at home.

Default Set Point = 50°C

Settable values = Automatic alignment with boiler limits

Note: T_{COM} > T_{ECO}

☰ Instant communication

It allows instant communication between device and APP during battery operation. Once communication has taken place, the device will communicate again at the pre-set intervals (default every 30 min, see also page 42).

Default value = OFF

OFF disabled

ON enabled

Note: during 230V mains operation, communication automatically switches to instantaneous frequency and this function is not visible.

☰ Reset basic settings (user menu)

After enabling and confirming the reset, the display switches off and the user menu settings are reset to default values.

Default value = NO

NO Reset disabled

YES Reset enabled

☰ Password

To prevent other users from changing the remote control settings, a password can be entered that will lock the keys. To enable this function, choose an access code with a value from 1 to 999. This code must be entered, followed by the MODE button, in order to access any remote control setting, from temperature control to basic or advanced parameters.

To disable the key lock, set the value to “0”.

3.5 - ADVANCED FUNCTIONS

Further remote control settings can be changed in the Advanced Functions menu:

1



1 to 4 sec.



Press and hold MODE until remote control is reactivated.

2



3 sec.



Press and hold both the UP and DOWN arrows for 3 seconds.

3



Use the central MODE button to scroll through the menu items (see list on page 22).

4

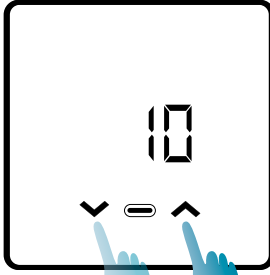

Use the arrows to change the settings of the selected item.



It is advisable that competent, qualified personnel change the P01 to P07 parameter values.

Saving of changes is confirmed by a flashing of the last parameter displayed. After saving, the display will return to Stand-by.

ADVANCED FUNCTIONS MENU

P01 | Communication protocol

This function displays the protocol used to communicate with the boiler.

PLS = OpenTherm® Plus

P02 | DHW Enabling

This function enables domestic hot water management.

Default value = OFF

OFF Disabled

ON Enabled

P03 Heating water temperature for fixed-point control

This function allows you to set the heating hot water flow temperature with fixed-point control.

By default the device is pre-set for installations with RADIATORS; these settings can be changed from the APP (see also page 24).

Default value = RADIATORS 70°C	20°C to 80°C*
FAN COIL = 46°C	30°C to 50°C*
RADIANT PANELS = 42°C	20°C to 45°C*

* These values automatically align with the boiler limits.

P04 Antifreeze temperature

This function avoids system blockage due to possible pipe freezing during the winter period.

Default value = 5°C	
OFF = off	
2.0°C to 7.0°C Antifreeze values	

P05 Adjustment type

You can select the type of adjustment you want to use.

- Fixed point: a fixed flow water temperature is set according to the selected system type: Radiators, Fan Coils, Radiant Panels (see also parameter P03).
- Climate control: the flow temperature is corrected according to the outside temperature to obtain a constant room temperature. The relevant parameters are set by default for RADIATOR systems and can only be customised via APP (see also page 23).
- Room correction: the flow temperature required by the device is corrected according to the set correction parameter value.

Default value = FP
FP: Fixed point
FPC: Fixed point with environment correction
CL: Climatic
CLC: Climatic with room correction

P06 Season

Change the season to activate control in heating mode with DHW or DHW only.

Default value = WI
WI = Winter (Heating + DHW if enabled)
SU = Summer (DHW only if enabled)

P07 Reset of advanced functions

After enabling reset, all remote control settings are reset to default values.

Default value = NO
NO = Reset disabled
YES = Reset enabled





3.6 - OVERVIEW OF MAIN EDITABLE FUNCTIONS

	C800WIFIOTRQ	IntelliClima+ APP
Mode selection (OFF - MAN - AUT - HOL)	•	•
Time profile programming (AUT - HOL - JOL - DHW)	-	•
DHW Enabling	•	•
Room temperature display	•	•
Comfort and Economy Temperature set point change	Temporary	•
Antifreeze temperature set point (winter only)	•	•
Summer/Winter operating mode (DHW only / Heating. + DHW)	•	•
Password setting (key lock)	•	•
Room temperature correction (OFFSET)	-	•
Upper and lower temperature limits (Heating and DHW)	-	•
Device LED brightness level	-	•
AP (Access Point) activation	•	-
Device Firmware/Softwareversion	•	•
Device serial number	Label	•
Device reset	•	•
Device battery status	•	•

FURTHER SETTINGS FROM APP

BOILER INFO display	•
WiFi router configuration	•
Defining synchronisation periods between remote control - App	•
Last remote control - App communication	•
App language selection (ITA-EN-FR-DE-ES-RU)	•
Device sharing with other users	•
SMART function: Self-learning (AGC)	•
SMART function: Geolocation	•
SMART function: CO ₂ energy saving display	•
SMART function: Open Window Management	•
Daylight Saving Time setting	•
Notifications on APP	•

4 - ERROR STATUS REPORTING

LED FLASHING	ERROR SIGNAL
 1min	1 RED flash per minute The batteries are running out and it is still possible to operate the device, but they need to be replaced;
 1min + Low Bat	1 RED flash per minute + Low Bat The batteries are exhausted, it is no longer possible to manage the device which will go OFF;
 1min	2 RED flashes per minute System glitch; we recommend checking the correct electrical connection and/or communication status with the boiler;
 1min	3 RED flashes per minute Missing DAY and TIME setting;

5 - USE FROM APP

It is also possible to proceed only with the configuration of the system parameters without immediately configuring the device to the actual home WiFi network.

5.1 - APP INSTALLATION

The **Intelliclimate+** App is available free of charge on Google Play Store and Apple Store. Frame the QR code to be taken directly to the link.



1

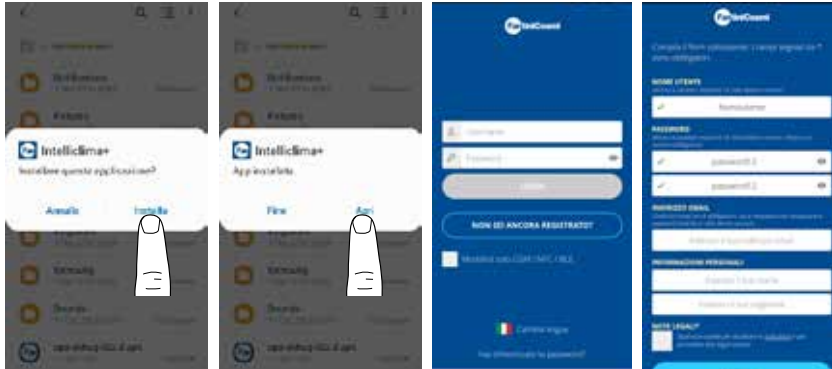

Install the **APP** and, upon first activation, **create an account** by entering the user name and password (an active data connection is required for this).

2



Create a new home by pressing **+** or enter GENERAL SETTINGS and press **ADD HOME**.

Enter the desired **HOME** name and press **CONFIRM**.

3

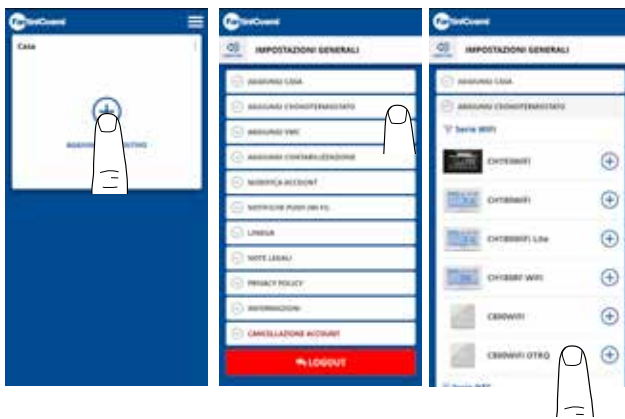

Add the remote control by pressing the **+** button and select **C800WIFIOTRQ**.

4

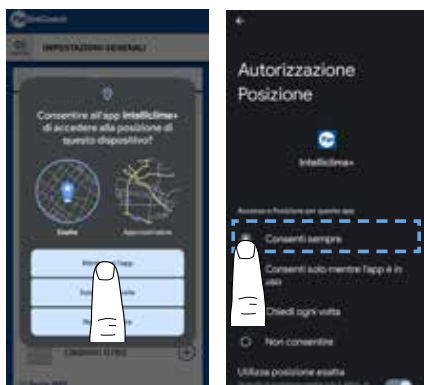

Important

To proceed with correct use of the **Intelliclimate+APP**, GPS position tracking must be authorised. If necessary, go into your smartphone settings and select **[ALWAYS]** from the options available when detecting the position from the **Intelliclimate+ APP**.

Any other setting could jeopardise smooth operation of the device management.

5.2 - SYSTEM CONFIGURATION

5



To proceed with device configuration, **the data network must be deactivated.**
Also check that you are connected to a Wi-Fi network.

6



Activate ACCESS POINT mode on the remote control.

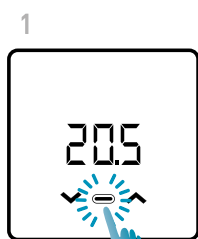

1 sec.



Press MODE to reactivate the remote control.



3 sec.



Press and hold MODE again for more than 3 seconds.

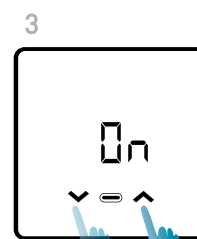

Use the arrows to select ON.

Saving of the setting is confirmed by a flashing of the last parameter displayed.
After saving, the display will return to Stand-by.

The device will remain in active AP mode (flashing) for about 15 minutes. When finished, the device will return to stand-by.

To force exit from AP mode, press and hold MODE for a few seconds.

7

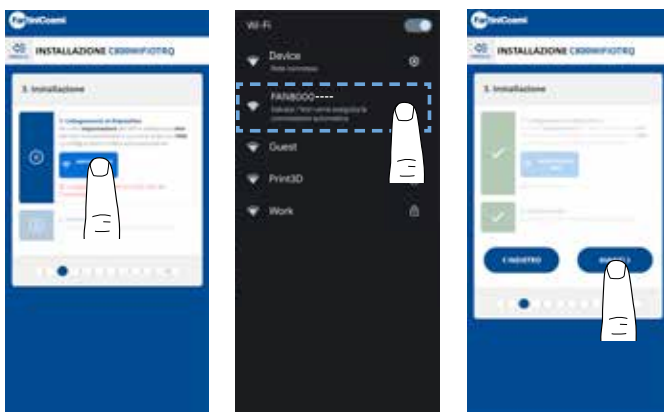

Press the WIFI SET-UP button to find the remote control.

Select the remote command beginning with FANxxxxx and wait for the message "CONNECTED, INTERNET NOT AVAILABLE" to appear, then return to the APP and proceed with the wizard.

8

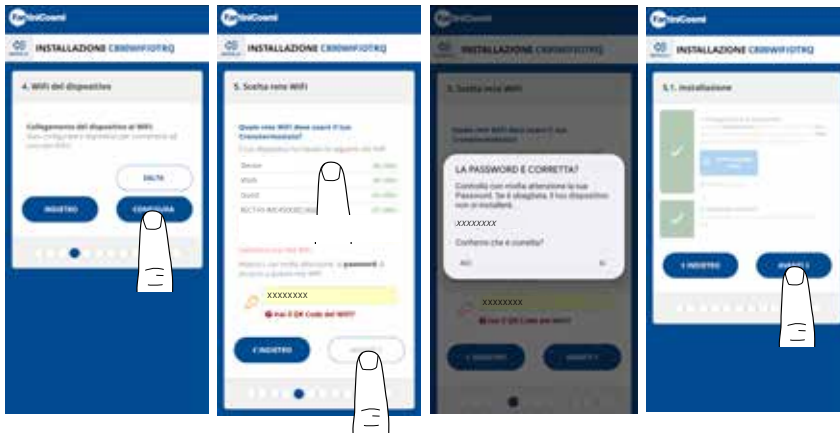

You can choose whether to configure the device to the WiFi network immediately or skip this step and only continue with the configuration of the system parameters (see step "6. BOILER CONFIGURATION").

When configuring the WiFi network, **carefully check the password** entered before confirming. In the event of an error, the device will not install itself and the configuration will have to be repeated.

9



It is possible to choose whether to configure the boiler system parameters immediately or to skip this step and only continue with customisation of the device in the house (see step "9. REMOTE CONTROL CUSTOMISATION IN THE HOUSE").



Configuration of the BOILER SETTING parameters should be carried out by competent and qualified personnel.

10

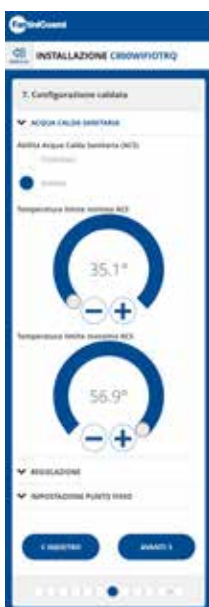

DOMESTIC HOT WATER

If the Domestic Hot Water management and control function is enabled, it is possible to set the min and max temperature limits to be applied to the boiler range.

Note: the range displayed by the system is automatically aligned with the parameters communicated by the boiler.

11



ADJUSTMENT TYPE

You can select the type of adjustment you want to use.

- Climate control = the flow temperature is corrected according to the outside temperature to obtain a constant room temperature (see also page 31).
- Room correction: the flow temperature required by the climate controller is corrected according to the set correction parameter value (see also page 34).



FIXED POINT

The fixed flow water temperature is set according to the type of system used (see also page 19 - parameter P03). Default:

Radiators	70°C
Fan Coil	70°C
Radiant Panels	42°C



CLIMATE CONTROL

The flow temperature is corrected according to the outside temperature to obtain a constant room temperature (see also page 31).



CORRECTIONS

You can set the correction values you want to use for the flow temperature required by the climate controller and/or the temperature set point.

K1 = room authority correction

K2 = set point correction

12



When all side ticks turn green, press the NEXT key.

13



Once you have completed the configuration of the remote control, you can choose **END** to confirm the selected parameters and exit the menu; or choose **CONFIGURE** to continue the configuration also with step "9. REMOTE CONTROL CUSTOMISATION IN THE HOUSE".

14



Follow the wizard to complete the configuration.

15

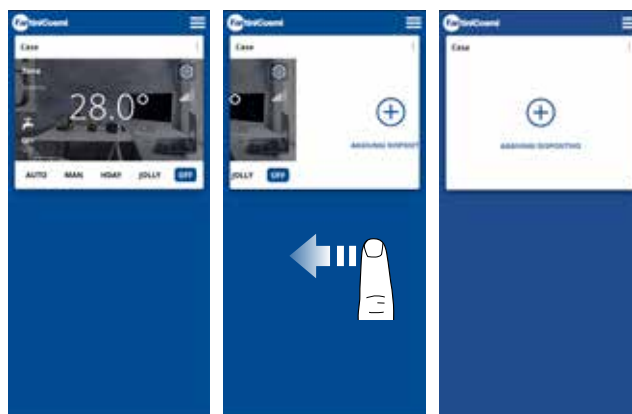

Once the configuration procedure is finished, it is possible to associate another device in the same home by swiping your finger on the display and then repeating the procedure from step 3.

5.3 - PROGRAMMING VIA APP



1	Home name
2	Zone name
3	Season
4	DHW enabled
5	Current set point
6	General App settings
7	Home settings
8	Device Settings
9	WiFi signal
10	Current room temperature
11	Server communication waiting time
12	Operating mode

5.3.1 - OPERATING MODE SELECTION

WEEKLY "AUTO" PROGRAM

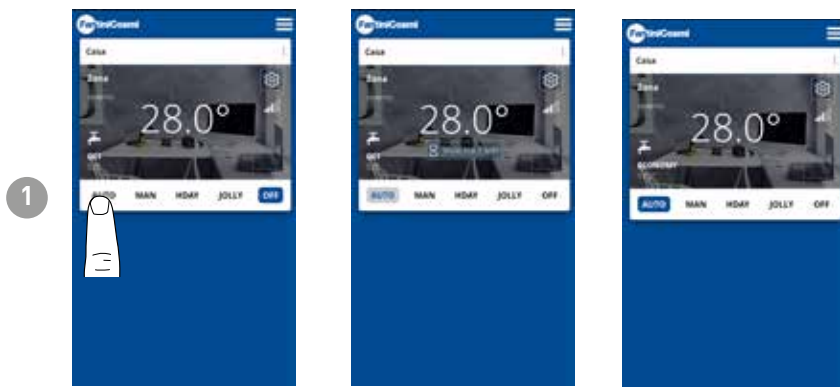

In AUTOMATIC mode the remote control works according to the time profiles set in PROGRAMS (see paragraph "4.4.1 - EDITING AUTO PROGRAMS").

Note: During battery operation, the C800WIFIOTRQ and the APP do not communicate in real time in order to preserve battery life, so changes made via the APP are not immediately picked up by the remote control but it is necessary to wait a certain amount of time (default every 30 min. in regular cycles defined by the device). The communication interval can be changed via APP (see APP manual at pdf.fantiniCosmi.it), All changes made via the APP during this time will be communicated to the device at the end of the time displayed on the countdown bar visible on the home page.

"MAN" MANUAL PROGRAM

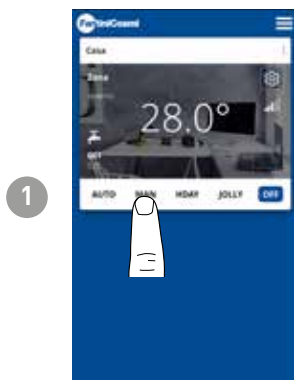

In MANUAL mode, the remote control works by following a single set point temperature throughout the day.

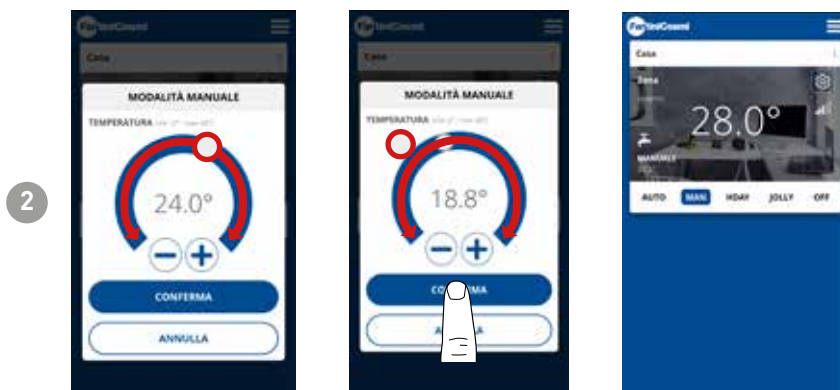

Move the Temperature slider to increase or decrease the Set point temperature.
Press **CONFIRM**.

DAILY "HOLIDAY" PROGRAM

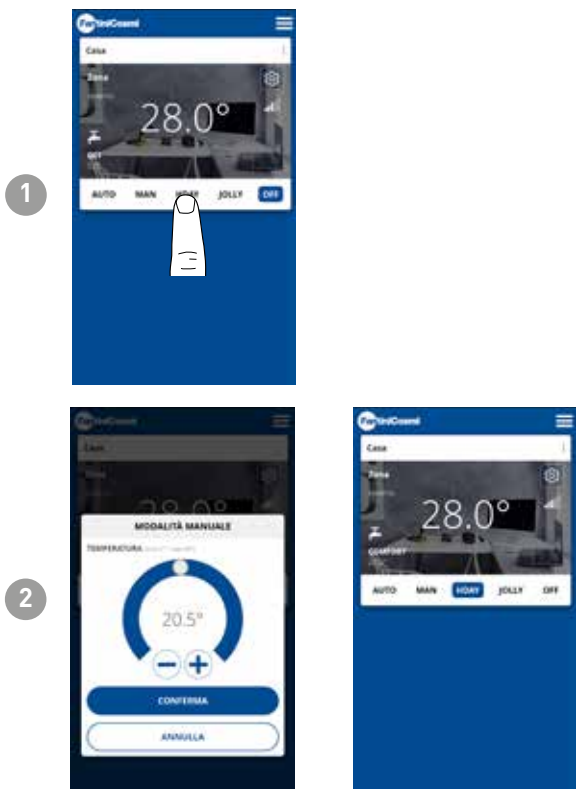

One of three programmable temperatures can be selected for each quarter-hour and this sequence will be repeated, identically, every day.

TEMPORARY "JOLLY" PROGRAM

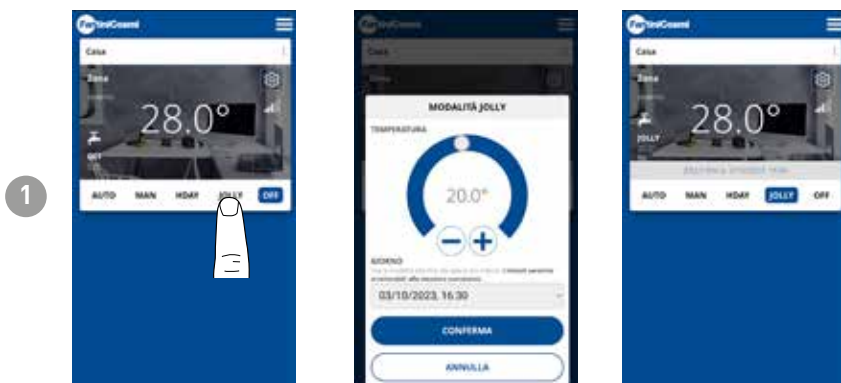

You can choose to maintain a certain temperature for a certain number of hours, after which the system will revert to the previously active program.

PROGRAM "OFF"

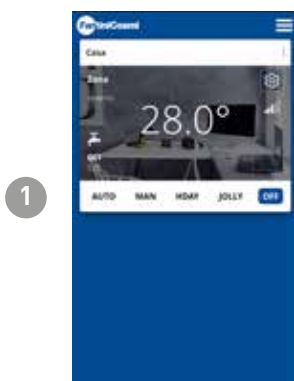

In OFF mode, the remote control is switched off or at antifreeze protection temperature if the function has been activated.

5.4 - DEVICE SETTINGS



Press the icon shown to access the general settings list for managing the C800WIFIOTRQ.

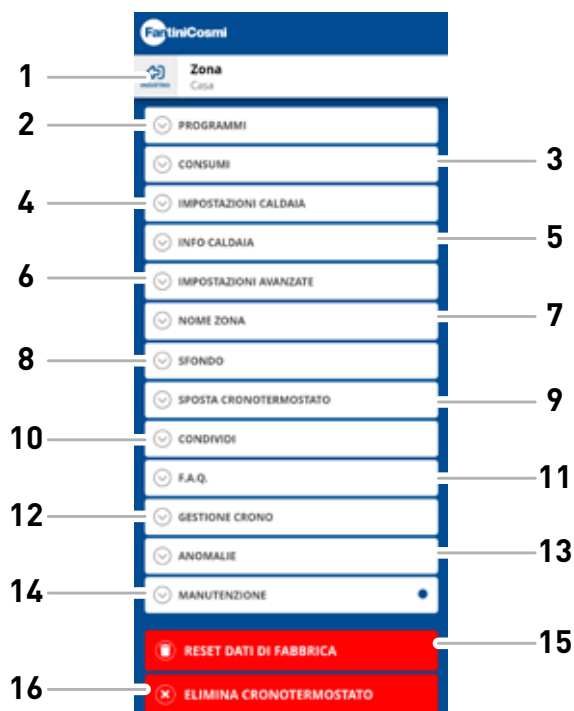

1	Back to HOME
2	Accesses the PROGRAMS sub-menu
3	Accesses the CONSUMPTION sub-menu
4	Accesses the BOILER SETTINGS sub-menu
5	Accesses the BOILER INFO sub-menu
6	Accesses the ADVANCED SETTINGS sub-menu
7	Changes the ZONE name
8	Changes the ZONE background
9	Moves device to another HOUSE
10	Share device
11	F.A.Q.
12	Device management
13	Anomalies
14	Maintenance
15	Factory data reset
16	Delete device

5.4.1 - EDITING AUTO PROGRAMS

Changing weekly programs for AUTO mode.



Different profiles can be created, edited, duplicated from the APP. Each day of the week can be associated with a different profile.

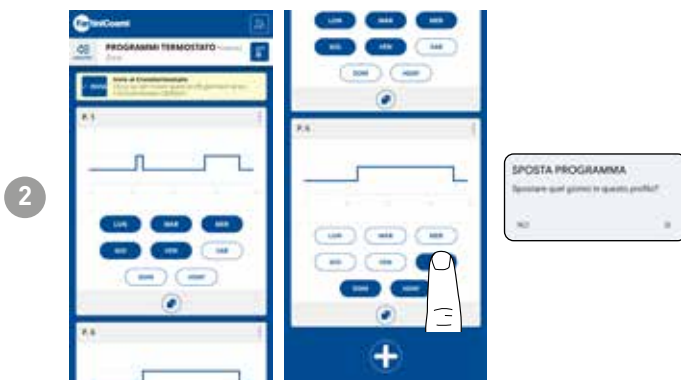

Choice of days of the week associated with the profile/program.



A PROFILE/PROGRAM can be duplicated and then edited.

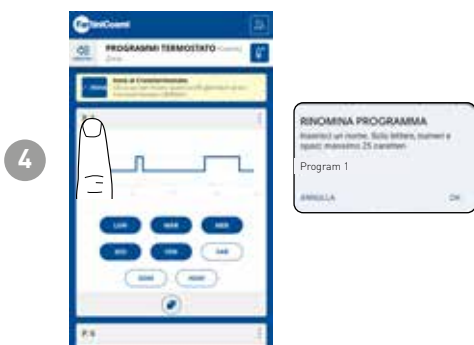

Press on the program name to change it.

Note: no two programs can have the same name.



Press the **+** button to create a new program.



To delete all changes and return the programs to the default configuration, press the **RESET** button.



Click on the profile to change it.



When you log in for the first time, the **TUTORIAL** with an indication of how to edit the profile is automatically displayed; otherwise, to display it again, press the **HELP** key.

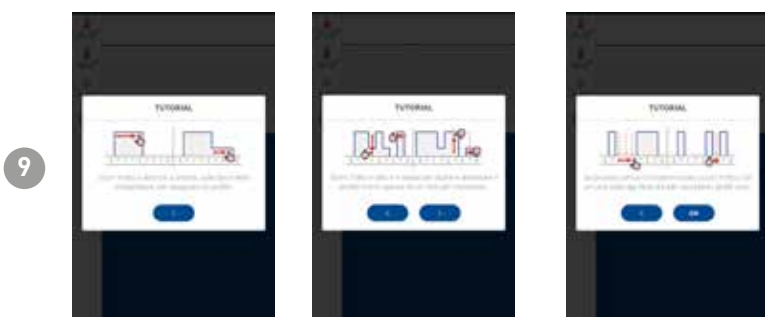

Follow the explanations.

10

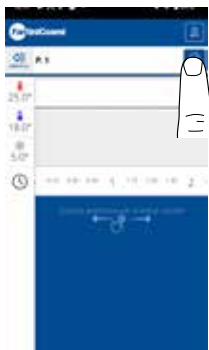

Change the program and press the SAVE button.

11

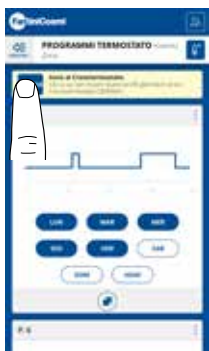

To send profile changes to the remote control, press the SEND button.

5.4.1.1 - EDITING AUTO TEMPERATURES

Changing **Comfort** and **Economy** temperatures for AUTO mode.

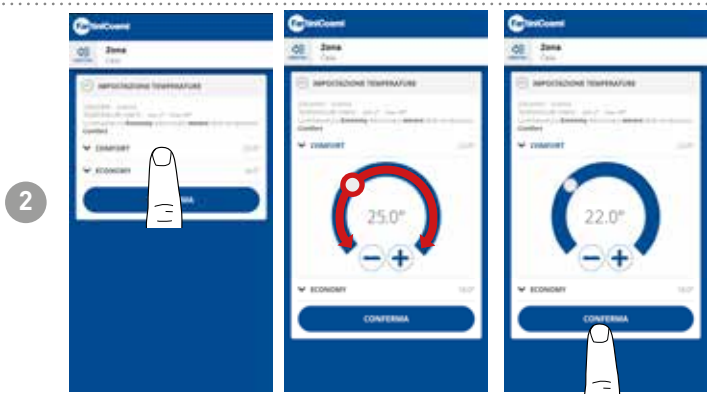
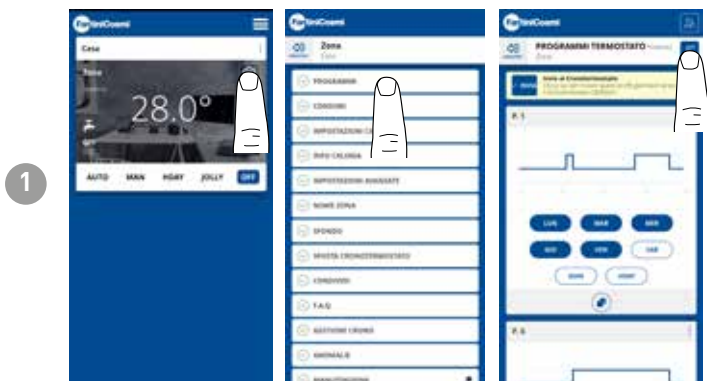

INFORMAZIONE
 Il tuo Climatizzatore C800WIFI OTRQ
 che permette di controllare la tua abitazione,
 in quanto cambia automaticamente perché
 attivato a rete.

Move the Temperature slider to increase or decrease the COMFORT temperature.
 Press **CONFIRM**.

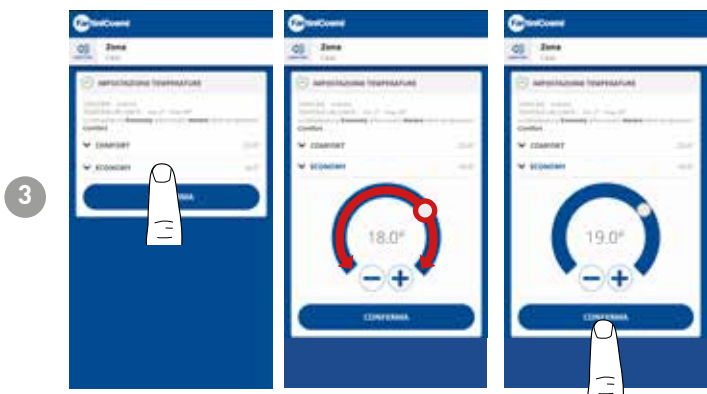

INFORMAZIONE
 Il tuo Climatizzatore C800WIFI OTRQ
 che permette di controllare la tua abitazione,
 in quanto cambia automaticamente perché
 attivato a rete.

Move the Temperature slider to increase or decrease the ECONOMY temperature.
 Press **CONFIRM**.

5.4.1.2 - EDITING PROGRAMS FOR DHW

Changing weekly programs for DOMESTIC HOT WATER mode (if enabled - see also page 18 - parameter P02).



Different profiles can be created, edited, duplicated from the APP. Each day of the week can be associated with a different profile.

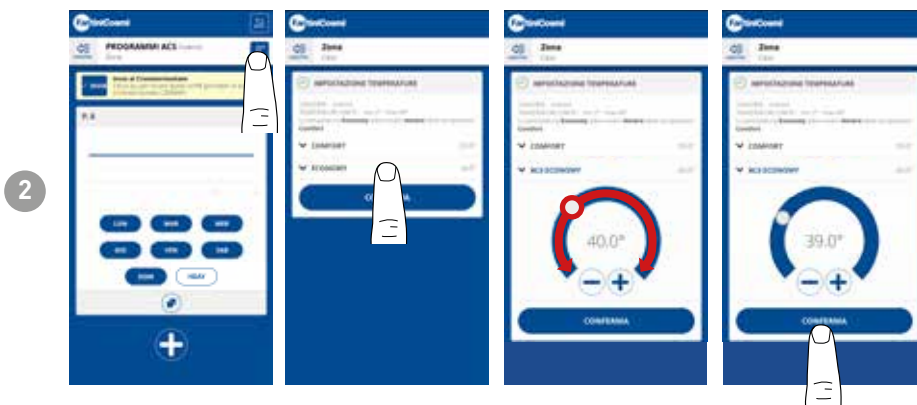

Move the Temperature slider to increase or decrease the COMFORT/ ECONOMY temperature. Press **CONFIRM**.

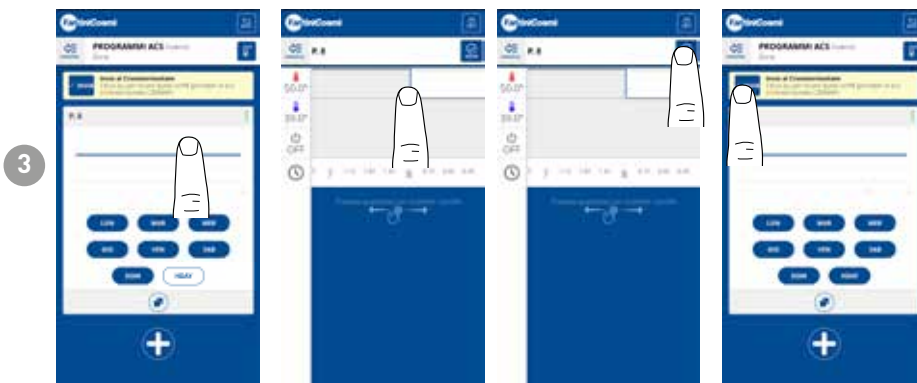

Click on the profile to change it. Then follow the instructions for changing the weekly programs for AUTO mode as shown on page 30.

4

5.4.2 - CONSUMPTION



From the APP it is possible to view the SYSTEM consumption (hours of operation), the remote control (BATTERY charge), and the POWER SAVINGS achieved through the C800WIFIOTRQ smart functions.

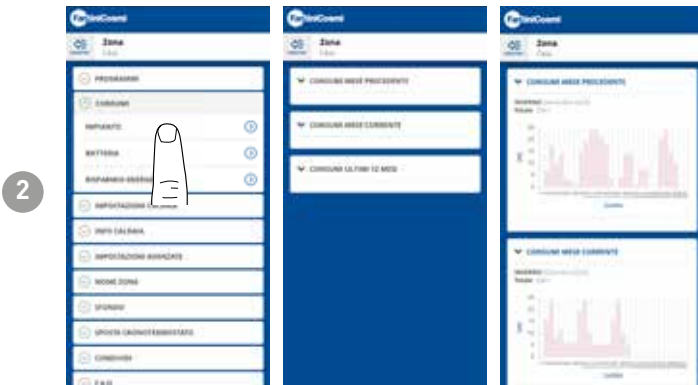

Display of system operating hours.

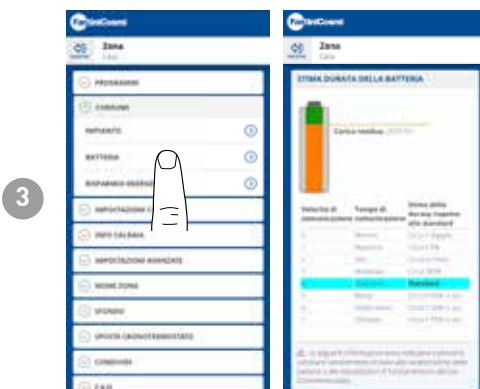

Display of battery status and estimated battery life based on set communication time.
Note: function only visible with battery-powered device.

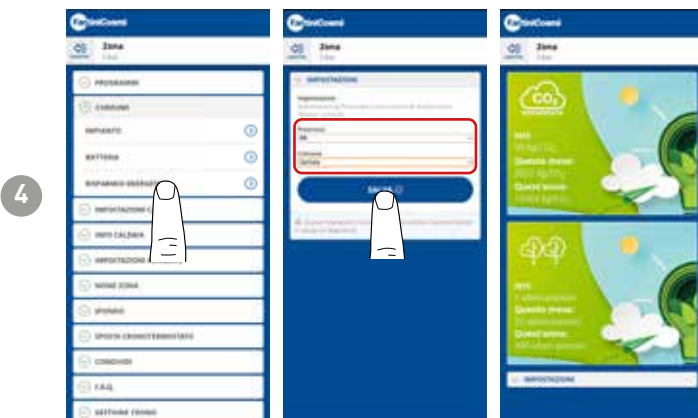

Displays the CO₂ savings obtained by activating the smart functions on the C800WIFIOTRQ compared to traditional remote control operation calculated according to the climate zone to which it belongs.

Saving CO₂ is equivalent to planting new trees, while increasing emissions is equivalent to cutting them down. This page shows the ecological footprint achieved by using a smart system.

5.4.3 - BOILER SETTINGS



From the APP it is possible to view and modify the boiler system parameters previously set during system configuration (see page 23 - Chapter 4.2 - SYSTEM CONFIGURATION)

 **BOILER SETTING** parameter configuration should be carried out by competent and qualified personnel.



If the Domestic Hot Water management and control function is enabled, it is possible to set the min and max temperature limits to be applied to the boiler range.

Move the Temperature slider to increase or decrease the COMFORT/ ECONOMY temperature.

Note: the range displayed by the system is automatically aligned with the parameters communicated by the boiler.

Press **CONFIRM**.

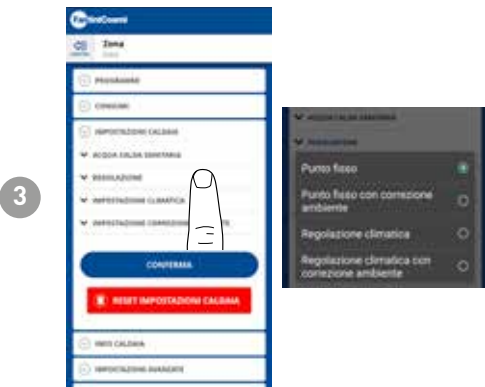

ADJUSTMENT TYPE

You can select the type of adjustment you want to use.

- Climate control = the flow temperature is corrected according to the outside temperature to obtain a constant room temperature (see also page 31).

- Room correction: the flow temperature required by the climate controller is corrected according to the set correction parameter value (see also page 34).



FIXED POINT

The fixed flow water temperature is set according to the type of system used (see also page 19 - parameter P03). Default:

- Radiators 70°C
- Fan Coil 70°C
- Radiant Panels 42°C

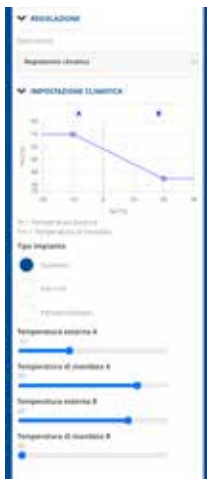

CLIMATE CONTROL

The flow temperature is corrected according to the outside temperature to obtain a constant room temperature (see also page 31).



CORRECTIONS

You can set the correction values you want to use for the flow temperature required by the climate controller and/or the temperature set point.

- K1 = room authority correction
- K2 = set point correction

5.4.4 - BOILER INFO

1

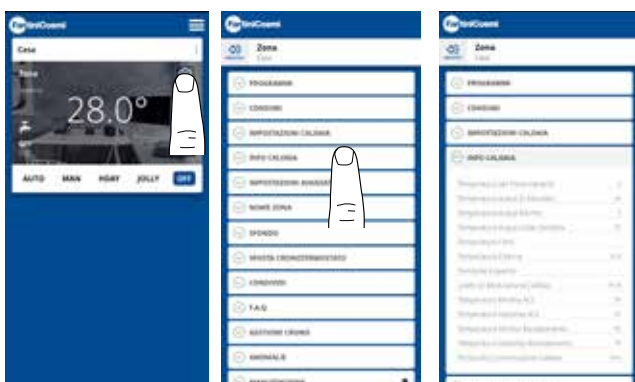

The parameters set and detected by the boiler are displayed.

5.4.5 - ADVANCED SETTINGS

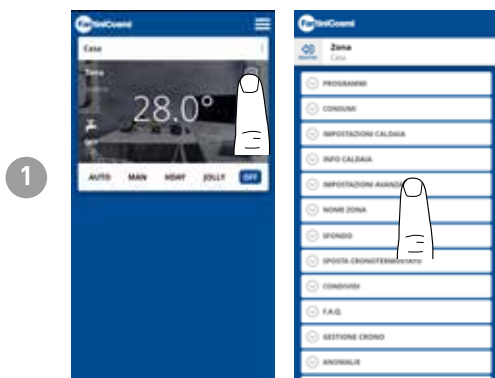

Press the icon shown to access the advanced settings list for managing the C800WIFIOTRQ.

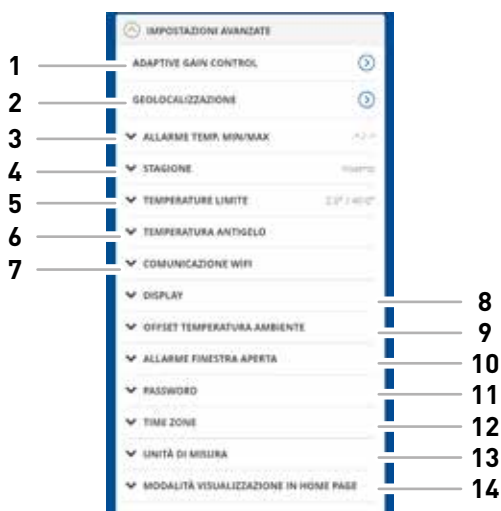

1	SMART function - Adaptive Gain Control (AGC)
2	SMART Function - Geolocation
3	Min/max. temperature alarm
4	Changes season
5	Changes temperature limits
6	Changes antifreeze temperature
7	Changes communication time between C800WIFIOTRQ and APP
8	Changes C800WIFIOTRQ display brightness
9	Changes settings (room temperature offset)
10	Open window alarm
11	C800WIFIOTRQ key lock
12	Time zone
13	Units of measurement
14	Home page display mode

5.4.5.1 - ADVANCED SETTINGS: ADAPTIVE GAIN CONTROL

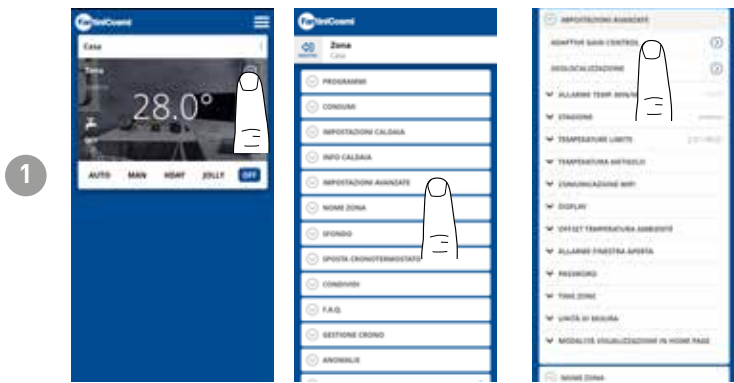

Thanks to artificial intelligence, the remote control progressively learns the arrival time of the systems based on the real conditions of the building, further optimising behaviour and consumption.

This enables the C800WIFIOTRQ to perform optimal start-up/shut-down control of the system to ensure the desired temperature at the desired time.

Note: activation of this SMART function is only possible in AUTO mode. If AGC is active, the GEOLOCATION function cannot be managed and vice versa.



After 7 days, the AGC function is ready to optimise the switching on and off of the system.
Press the ACTIVATE key.

Note: when the 7 days expire, an ALERT notification appears on the APP.



Activate the system ANALYSIS function, which will last 7 days.

5.4.5.2 - ADVANCED SETTINGS: GEOLOCATION

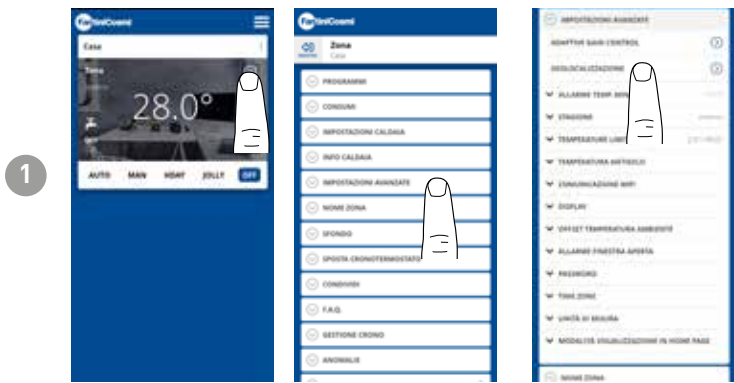

This function calculates the distance from home of your smartphone and adjusts the set point to avoid unnecessary energy waste when you are away from home.

Note: activation of this SMART function forces the remote control to operate in MAN mode by automatically changing the set point temperatures (inside the home = Tcomfort; away from home = Teconomy).

If GEOLOCATION is active, the AGC function cannot be managed and vice versa.

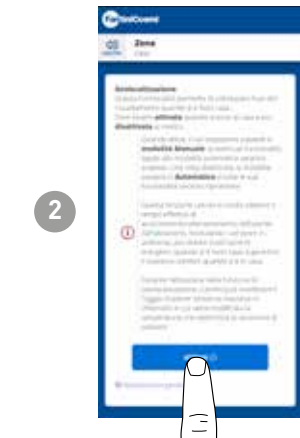

From GENERAL SETTINGS you can change the RANGE OF ACTION (indicates the maximum distance in kilometres in which the temperature is changed) which determines the set point change. When your smartphone is outside the indicated threshold, the remote control set point reaches the Teconomy value set in the AUTO configuration.

5.4.5.3 - ADVANCED SETTINGS: MIN/MAX TEMP. ALARM

Activates an alarm signal if the Room Temperature is lower than the set Minimum Temperature and/or higher than the set Maximum Temperature.

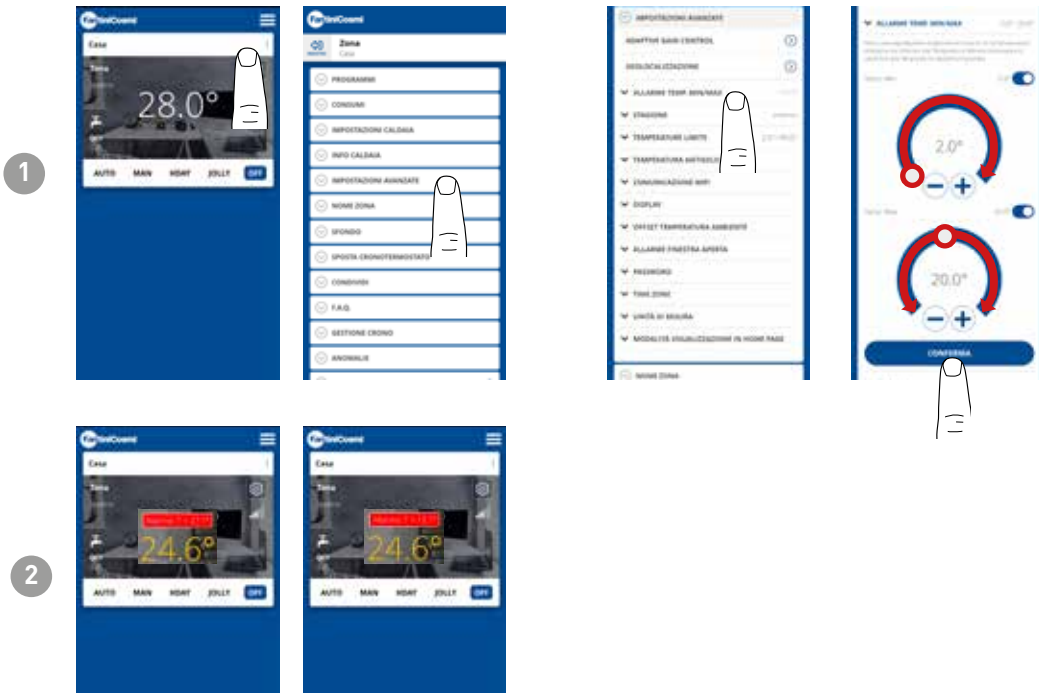

5.4.5.4 - ADVANCED SETTINGS: SEASON

Changes the Season (Summer/Winter) of operation of the remote control.



Winter = Heating + DHW (if enabled)
 Summer = DHW only (if enabled)

5.4.5.5 - ADVANCED SETTINGS: TEMPERATURE LIMITS

Changes the max. and min. set point limits of settable temperatures.

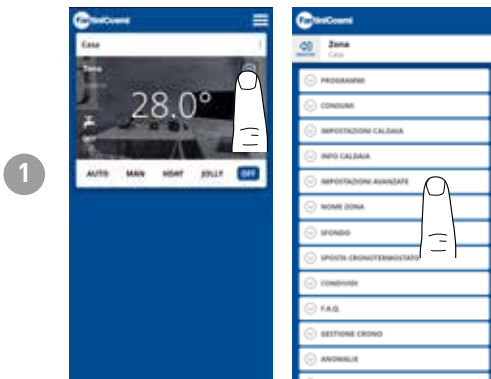

Note: only qualified personnel should perform this modification.

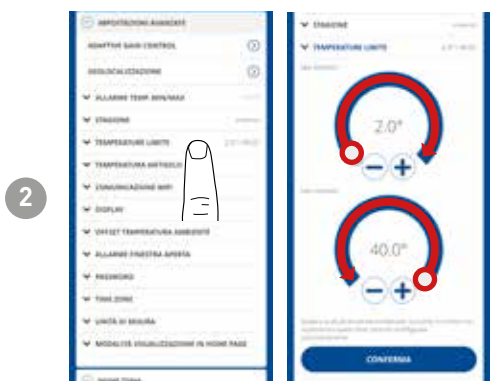

Move the slider to increase or decrease the limit temperatures. Press **CONFIRM**.

5.4.5.6 - ADVANCED SETTINGS: ANTIFREEZE TEMPERATURE

Changes the antifreeze temperature.

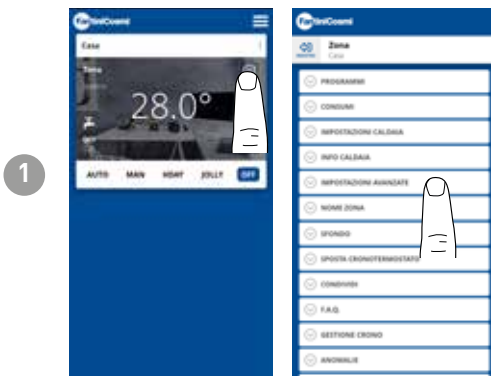

- Settable ANTI-FREEZE: 2° to 8°C; 0.1°C resolution.

Note: only qualified personnel should perform this modification.

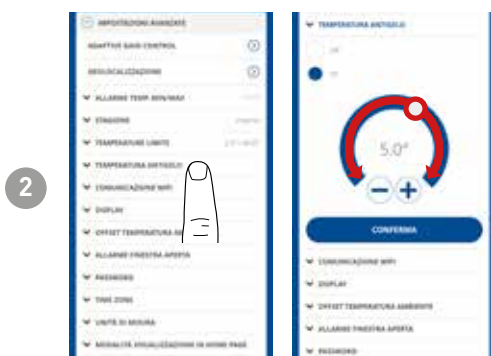

Move the slider to increase or decrease the Antifreeze temperature. Press **CONFIRM**.

5.4.5.7 - ADVANCED SETTINGS: COMMUNICATION

Allows the communication time between device and APP to be changed during battery operation.

Note: during 230V mains operation, communication automatically switches to instantaneous frequency and this function is not visible.

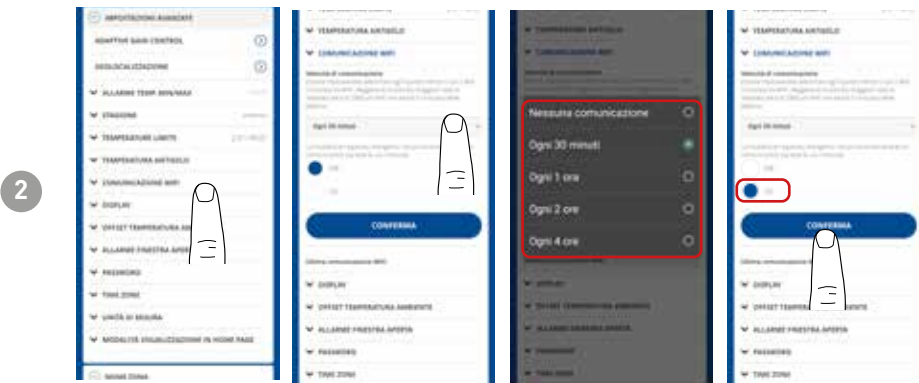
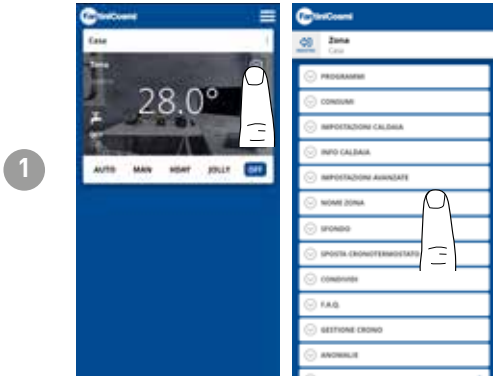

IMPORTANT: the shorter the set communication time, the higher the battery consumption.

When power saving mode is selected, the system automatically reduces the frequency of communication during night hours to preserve the device's battery life.

5.4.5.8 - ADVANCED SETTINGS: DISPLAY

Changes the brightness of the C800WIFIOTRQ display.

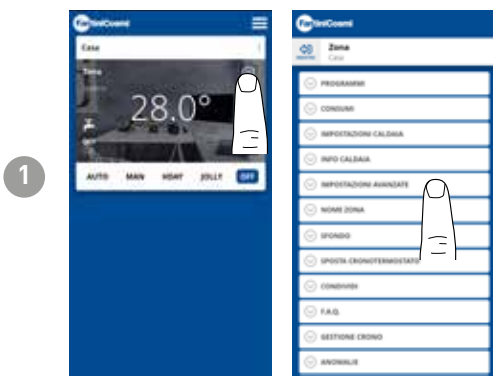

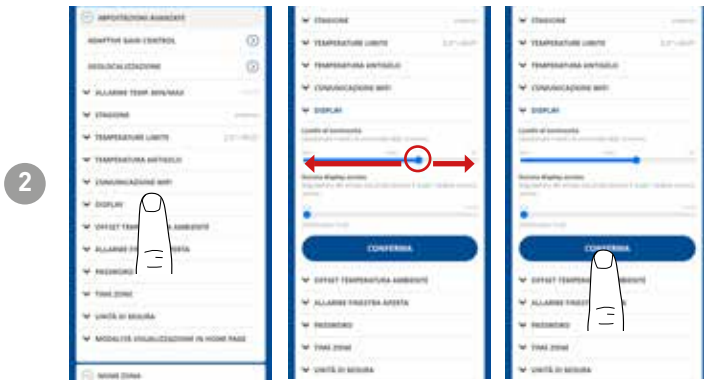

Move the slider to increase or decrease the brightness level of the display.
Press **CONFIRM**.

5.4.5.9 - ADVANCED SETTINGS: ADJUSTMENTS

From the APP, you can change the control differential of the C800WIFIOTRQ and the offset of the temperature read by the remote control.

Note: both settings should be changed by trained personnel only.

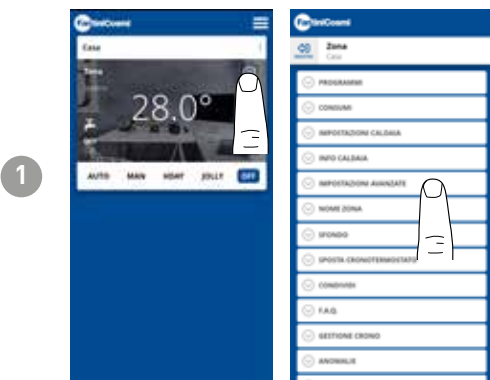

- DIFFERENTIAL can be set to values: Standard; 0.3°C to +5°C; resolution 0.1°C
- OFFSET: settable from -5°C to +5°C; resolution 0.1°C

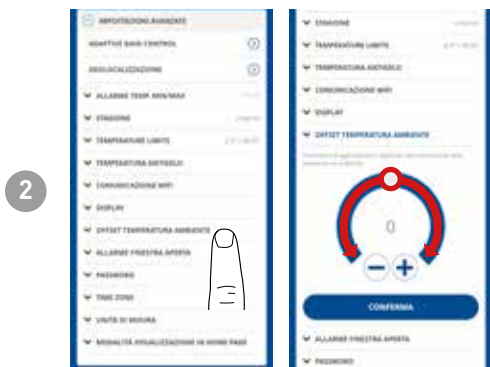

Move the slider to increase or decrease the temperature differential and/or offset.
Press **CONFIRM**.

5.4.5.10 - ADVANCED SETTINGS OPEN WINDOW ALARM

Open window detection uses sudden temperature changes to detect whether a window is open. In this case, an alarm is sent and the remote control switches to Economy mode. It will remain there until the window is closed or the alarm is reset.

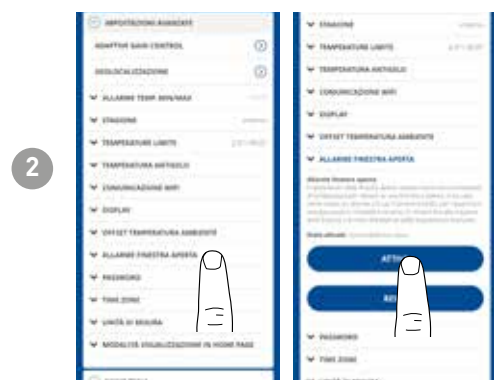
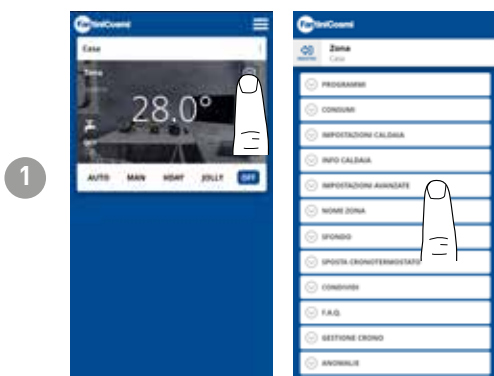

5.4.5.11 - ADVANCED SETTINGS KEY LOCK

Activating the Key Lock function will lock the keys on the remote control.

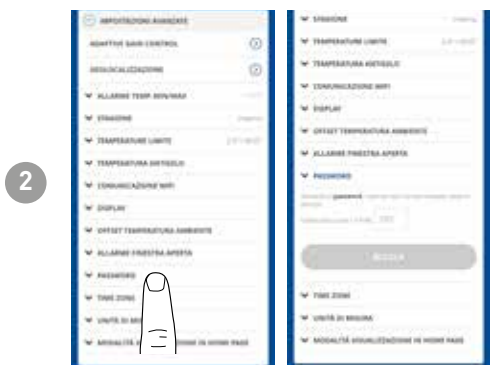
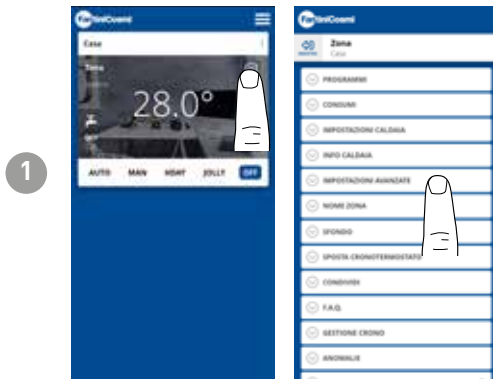

5.4.5.12 - ADVANCED SETTINGS TIME ZONE

The user can decide whether or not to activate DAYLIGHT SAVINGS automatically or manually.

He or she can also set a TIME ZONE different from the one automatically taken by the smartphone. Example: the C800WIFIOTRQ is installed in a city other than the one you normally live in, with a different time zone from the smartphone.

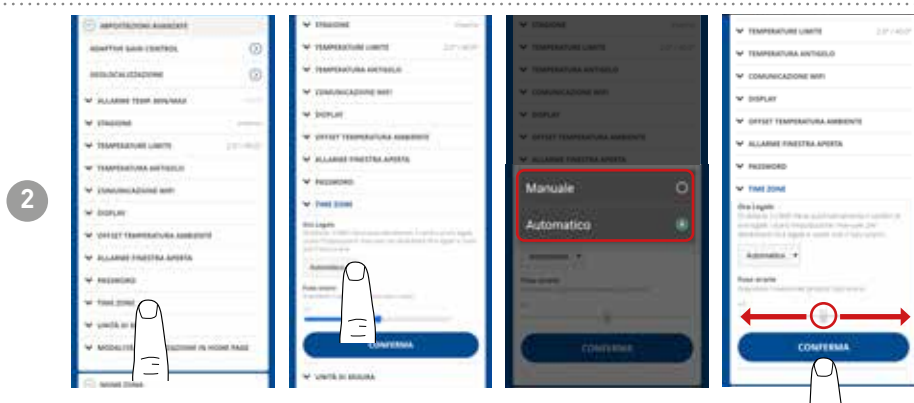

5.4.5.13 - ADVANCED SETTINGS UNITS OF MEASUREMENT

The user can decide which scale to use to display temperatures.

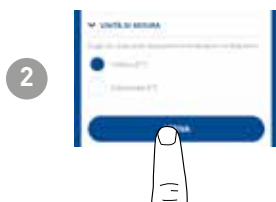
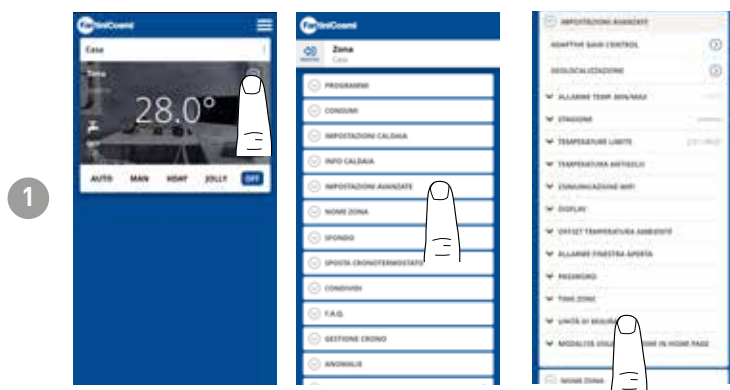

5.4.5.14 - ADVANCED SETTINGS HOME PAGE DISPLAY MODE

The user can decide whether to display the room temperature detected by the device or the set temperature on the home page.

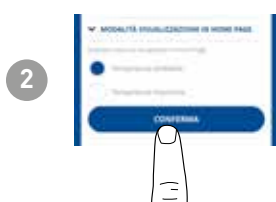

5.4.6 - ZONE NAME

Changes the name of the zone where the remote control is installed.

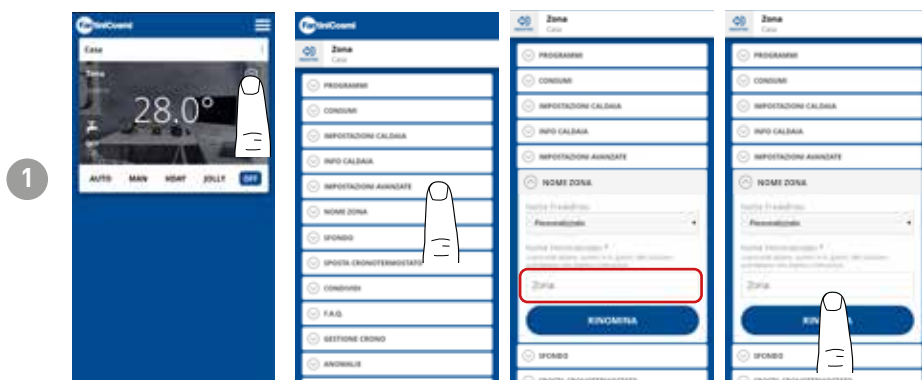

5.4.7 - BACKGROUND

Changes the background of the area where the remote control is installed.

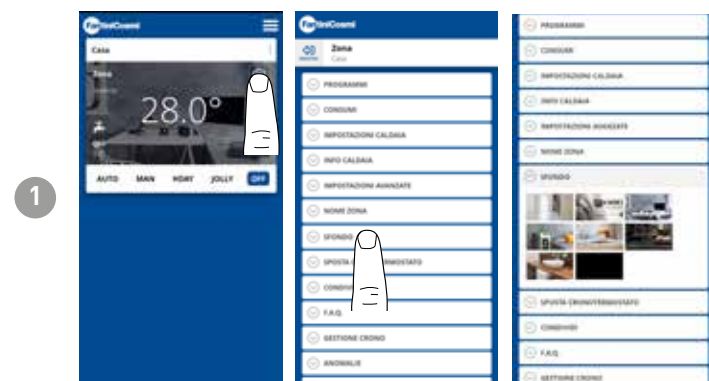

Default photos can be used and inserted as wallpaper.

5.4.8 - MOVE DEVICE

It is possible to move the remote control from one house to another.



5.4.9 - SHARE

Allows remote control to be shared with other users. You only need to enter the other user's account name and press the ADD key.

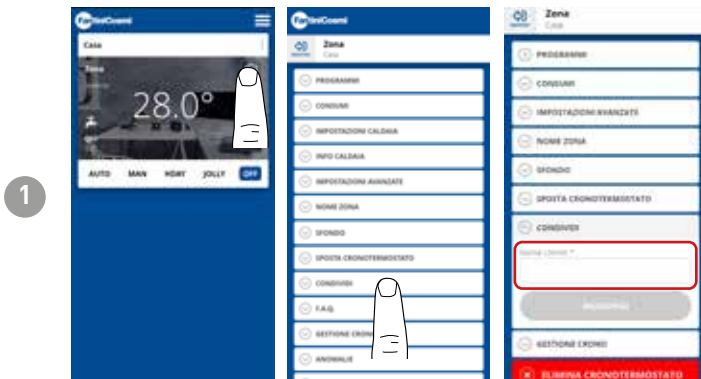

Note: the “sharing” user has reduced functionality on the APP compared to the “owner” user of the remote control.

5.4.10 - F.A.Q.

Questions and answers on the C800WIFIOTRQ remote control



You can consult these questions and answers from the link www.fantincosmi.it/faq-C800WIFIOTRQ/ or directly via the App with the F.A.Q. button.

5.4.11 - DEVICEMANAGEMENT

In this section, you can obtain general information on remote control and reprogramming of the WiFi network.

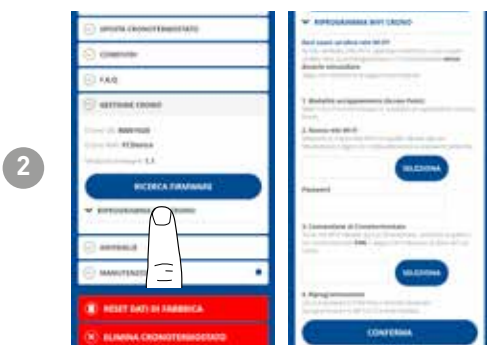
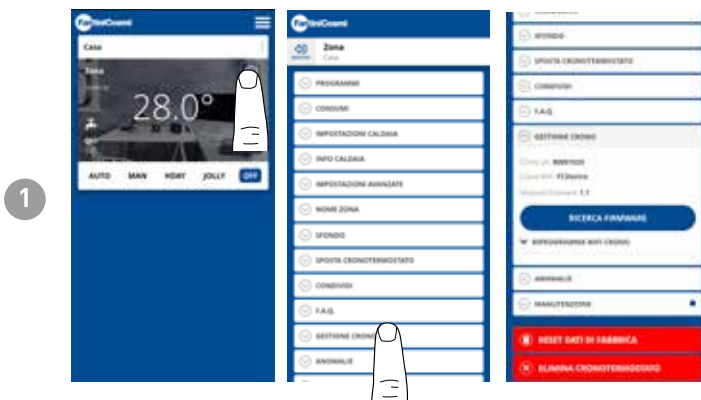

If you change routers, you can hook the remote control to the new router without having to redo the installation from scratch.

5.4.12 - ANOMALIES

Allows active faults on the device or boiler to be displayed.

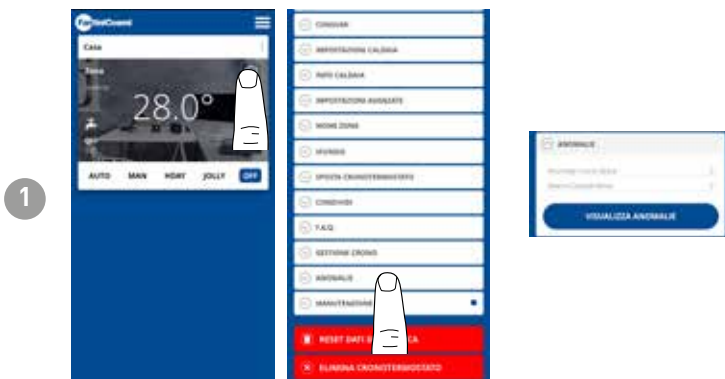

5.4.13 - MAINTENANCE

This section facilitates boiler maintenance by receiving notifications of the scheduled maintenance period.



5.4.14 - FACTORY RESET

Allows settings to be reset back to factory settings.

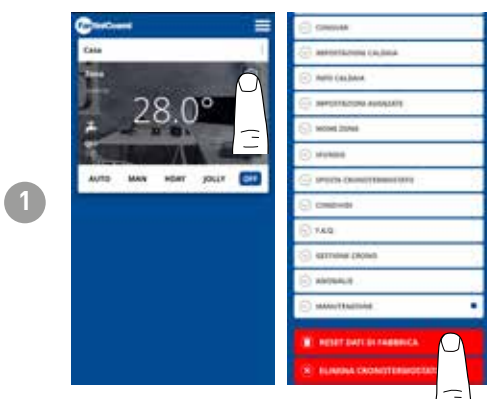

5.4.15 - DELETE DEVICE

Allows the remote control to be removed from the house with which it is associated.

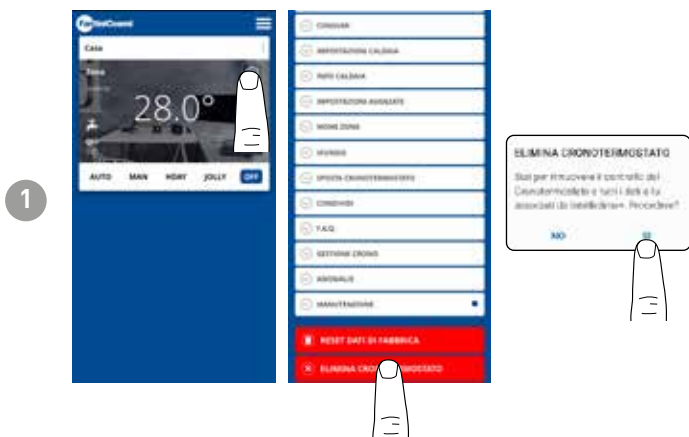

Note: this operation cannot be restored with a CLICK! You would have to reinstall the remote control from scratch, following all the steps.



5.5 - HOME SETTINGS

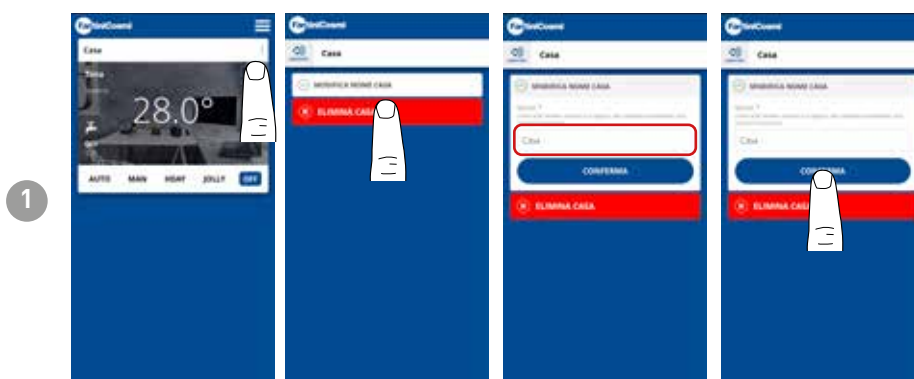

Allows you to **change** the name of the selected **home**.

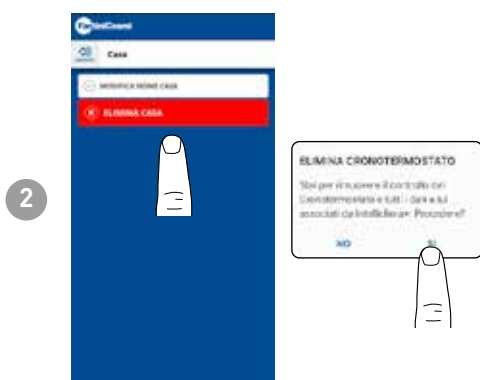

Allows you to **delete** the selected **home**.

5.6 - GENERAL APP SETTINGS

1



Press the icon shown to access the general settings list for managing the *INTELLICLIMA+* App

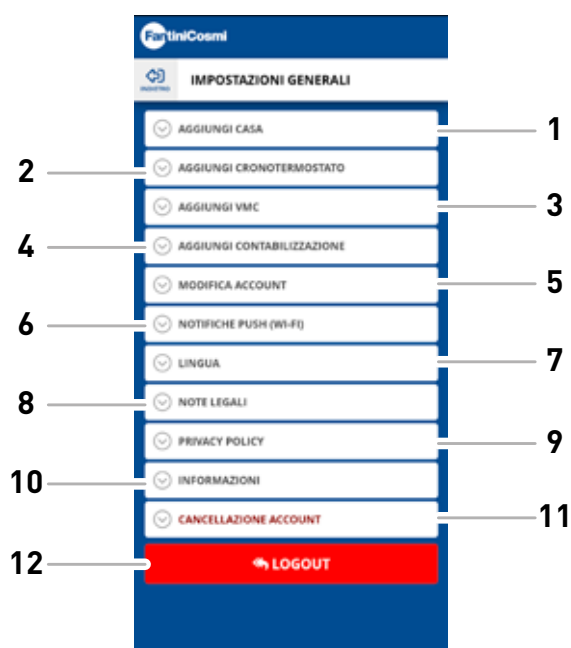

1	Add HOME
2	Add PROGRAMMABLE THERMOSTAT
3	Add VMC
4	Add METERING
5	Edit account
6	Push notifications (WiFi)
7	Language
8	Legal notes
9	Privacy Policy
10	Information
11	Delete account
12	LOGOUT

5.6.1 - APP SETTINGS: PUSH NOTIFICATIONS

PUSH notifications are the alerts that arrive on the mobile phone if there are various anomalies in the operation of the *Intelliclimate+* system of **C800WIFIOTRQ**.

Note: these only work on WiFi devices and if you activate data service on your smartphone.

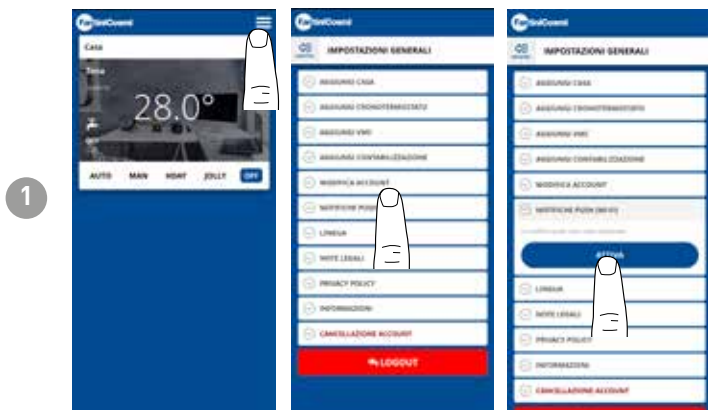

5.6.1 - APP SETTINGS: LANGUAGE

Change the *Intelliclimate+* App consultation language.



For further information and assistance please contact your installer or write to supportotecnico@fantinicosmit.it indicating the model in use and the problem encountered.

6 - DISPOSAL



The symbol of the crossed-out wheeled bin indicates that the products must be collected and disposed of separately from household waste. The batteries and integrated accumulators may be disposed of together with the product. They will be separated at the recycling facilities. A black bar indicates that the product was placed on the market after August 13th, 2005. Participating in the separate collection of products and batteries contributes to the correct disposal of these materials and therefore avoids possible negative consequences for the environment and human health. For more detailed information on the collection and recycling programs available in your country, contact the local authorities or the sales point where you purchased the product.

7 - GENERAL WARRANTY CONDITIONS

The conventional warranty lasts 24 months, starting from the date the equipment is installed. The warranty covers all parts of the equipment, except those subject to normal wear and tear resulting from use.

EAC CE

Code 568034APP - 7/2024



FANTINI COSMI S.p.A.

Via dell'Osio, 6 - 20049 Caleppio di Settala, Milan - ITALY
Tel. +39 02 956821 - info@fantinicosmi.it
www.fantinicosmi.it

TECHNICAL SUPPORT
supportotecnico@fantinicosmi.it

EXPORT DEPARTMENT
export@fantinicosmi.it